

Merging Interstage Fractionation and Low Consistency Advantages During the TMP Refining Process: Part III – How Fibre Morphology Impacts Paper Properties

My-Mustapha Lemrini,^a Robert Lanouette,^{a,*} and Gaston Michaud^b

Fibre morphology and its evolution during refining and fractionation at low consistency were studied to understand the key relationships between the mechanical properties of paper and those of fibres. A broad analysis is presented on the physical and mechanical properties characterising the intrinsic morphological properties of fibres. The experimental refining process involved a primary stage at high consistency (HC), a fractionation stage with a small aperture basket, a low consistency (LC) refining stage, and a final high consistency refining (HCR) stage. The idea was to benefit from the pulp already being at low consistency following the screening step. Using a higher proportion of low consistency refining (LCR) tended to lower the tensile strength at 100 mL CSF, but some intermediate values did exhibit better responses to refining. Fractionation permits the use of LCR to retain fibre length and to develop additional long fibre bonding. The net gain remains even with energy reduction. It is believed, among other things, that a greater number or greater intensity of fibre-to-bar contacts would help increase internal delamination of the fibre structure.

Keywords: Low consistency refining; Fractionation; Selective refining; TMP; Energy reduction; Properties

Contact information: a: Lignocellulosic Material Research Center (LMRC), UQTR, CP 500, Trois-Rivières, QC, G9A 5H7 Canada; b: Innofibre, Cégep de Trois-Rivières, CP 97, Trois-Rivières, QC, Canada, G9A 5E6; *Corresponding author: Robert.Lanouette@uqtr.ca

INTRODUCTION

This research aims to understand how fibre morphology impacts paper properties. In order to do so, the relationships that may exist between fibre properties and variations of the physical properties of a sheet were studied.

Several authors have studied this topic from various angles and have come to a range of conclusions. Replacement of high-consistency refining (HCR) in the second stage with a low consistency refining (LCR) stage reduces total energy demand to achieve a tensile index of 40 Nm/g at 1.1 MJ/kg for Norway spruce (Hammar *et al.* 1997; Eriksen and Hammar 2007). The various fractions can be used separately in different products or can be further improved by appropriate treatment and recombination. This can improve the quality of products and generate energy savings (Corson *et al.* 1995; Sandberg *et al.* 1997; Wakelin *et al.* 1999; Ouellet *et al.* 2003).

Replacing the second high consistency refining stage by a low consistency refining showed a reduction of the total energy demand to achieve a tensile index of 40 Nm/g of 1.1 MJ/kg for Norway spruce (Hammar *et al.* 1997; Eriksen and Hammar 2007). ATMP studies at pilot scale also demonstrated a reduction of 0.4 to 0.7 MJ/kg of total refining energy, compared at a similar tensile index of 40 Nm/g when the second HC

refining stage was replaced by multiple LC refining stages; the total refining energy was less than 3.6 MJ/kg (Sabourin 2007; Sabourin *et al.* 2011).

Recent studies on a second LC refining stage at an industrial scale have shown that it is possible to reduce the gross energy demand by about 0.4 MJ/kg by using an LC stage (Andersson and Sandberg *et al.* 2011; Andersson 2011). Low consistency refining is employed nowadays in commercial mechanical pulping in combination with primary-stage HC refining (Andersson 2011). The degree of external fibrillation of the fibre surface was found to be lower for LC-refined pulp compared to HC-refined pulp at equal tensile indices (Hafrén *et al.* 2014).

The influence of low-consistency refining on the surface chemical and morphological properties of softwood chemical pulp was investigated by Mou *et al.* (2013) using a special laboratory refining station and advanced topochemical analysis. They showed that refining modifies the surface chemistry and morphology of fibres, presumably by making structural changes in the fibre cell wall composition.

Gorski *et al.* (2012) proposed that, while HC refining resulted in a significant reduction in fibre wall thickness associated with fibre collapse and increase in external fibrillation, LC refining mainly generated structural changes, which may be seen in fibre straightening and increased flexibility. Extensive internal fibrillation of the straighter LC refined fibres appeared to have compensated for lower fines content and external fibrillation, producing well-bonded sheets with good tensile strength.

In Part I of this research series, it was established that some properties are maintained with energy savings nearing 50% when using LCR (Lemrini *et al.* 2013). Other properties are altered even when HC is used with fractionation. The processes studied were aimed to develop a pulp that requires less refining energy compared to pulp produced using conventional methods. The multiple LCR/HCR combinations used in this study yield a variety of pulps with different properties. This suggests the possibility of reducing energy input while maintaining the quality of the final pulp. In Part II of this research series, the morphological changes caused by varying refining consistency for both whole pulp refining and long fibre selective refining were evaluated (Lemrini *et al.* 2014). Both consistency and fractionation cause important changes in fibre development.

To understand how fibre morphology impacts paper properties, this research is concentrated on thoroughly studying tensile development. At a freeness (CSF) of 100 mL, tensile is studied as function of refining energy considering certain other variables with known impacts on tensile. When compared to other mechanicals properties which did not vary that much, tensile has shown greater variations. To better understand the cause of these variations we do rely the tensile variations to morphological changes which may subsequently occur. That is why we thought it would be of unique interest to deepen our research, especially toward the morphological fibre behaviour when using these tensile variations versus the others properties.

EXPERIMENTAL

The pulp used in this experiment resulted from a Canadian primary refining from Kruger mill located in Trois-Rivières, Québec and had the following characteristics: 75% (average) spruce and 25% (average) balsam fir with 555 mL freeness and 1.73 mm length-weighted fibre length. The long fibre fraction was refined under LCR and HCR

conditions. The LCR and HCR were conducted at the LMRC center. The HC refining was performed on a Valmet CD300 pilot refiner, 12 inches single disc with a conical section, with a 2 metric tons daily capacity, under atmospheric conditions. The consistency was 12.2% to 16. Based on numerous trials done for various Canadian mills in our centre, and considering the small size of this refiner, this used consistency has been found to impart a similar effect to the pulp as a larger-size industrial refiner, even though the consistency is much lower. Paper physical properties as well as fibre morphology resulting from the refining have been found to be similar.

An LCR using a conical Valmet Optifiner RF-0 was selected for this study. The gap was adjusted to decreasing values. For each of these values and when the power was stabilized, pulp refined during a specified period of time was retained and weighed. During the same time, the energy consumption was registered. The primary pulp was refined conventionally (P1A and P1B in Fig. 1). The primary TMP was fed directly to the HC refiner for the P1A trial. In the case of the P1B trial, the pulp was suspended with the aid of a high consistency pulper and was transferred to the low consistency refiner feed tank, where the consistency and temperature were adjusted to 4% and 50 °C, respectively. These two basic processes were compared to an experimental refining process involving a fractionation stage with a small aperture basket, a low consistency refining stage, and a final high consistency refining stage (P1C in Fig. 1). The idea is to benefit from the pulp already being at low consistency following the screening step.

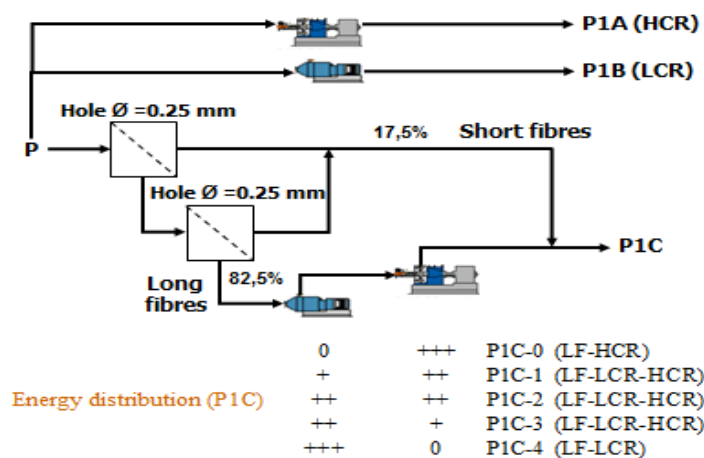

Fig. 1. Experimental process

It is convenient to do a low consistency refining stage prior to thickening before the high consistency refining stage. Since the low consistency refining is more aggressive, a reduction in energy expenditure is expected, possibly without a reduction in quality. This fractionation method has proven to be an efficient way to separate primary pulp into two fractions after several fractionation strategies were tested by Ferluc *et al.* (2010). The primary pulp was fractionated with a Black Clawson model 8P pressure screen equipped with a two-foil open rotor rotating at a tangential speed of 20 m/s to obtain two fractions: a short and a long fibre fraction. The fractionation process consists of a two-stage cascade with a 0,25 mm smooth holes basket. The short-fibre fraction is neither treated nor refined so it goes directly into the final pulp with the long-fibre fraction (which is refined prior to recombination through LCR, HCR, or some LCR/HCR

combination). For the PIC test, the latency was removed from the primary pulp in a high consistency pulper where it rested for at least 1 h at a consistency of 4.33% and a temperature of 80 °C. The pulp was transferred to a tank where it was diluted to a consistency of 1% and kept at a temperature of 50 °C. The pulp was then fractionated through a 0.25-mm smooth-hole basket. The short-fibre fraction from the primary stage (fraction A1) was collected in a tank while the rejects of the first screening stage were accumulated in another. Rejects were then transferred to a tank, diluted to 1%, and held at 50 °C. They were then split again using the same screen. The short-fibre fraction of the secondary stage (fraction A2) was stored in a tank while the long-fibre fraction was accumulated in another. Primary TMP was fractionated according to the mass proportions listed in Table 1. The fractionation stage gives 82.5% long fibres and 17.5% short fibres (Table 1). No wasted fines nor short fibre loss is suffered as fines and short fibre are kept secure and are added to the long fibre portion at the final stage, where they are used as a dilution water.

The long-fibre fraction is the only fraction that underwent LCR and HCR. The LCR and HCR processes were conducted at the LMRC. The HCR was performed on one of the two Valmet CD300 pilot refiners (Valmet, Finland), each with a 2-metric-ton daily capacity. Low consistency refining using a conical Valmet conical refiner RF0 was carried out for this study. The gap was adjusted to reach the desired CSF values.

For the PIC pulps, different energy levels were applied from 100% of the secondary stage refining energy at LC and 0% at HC to 0% applied at LC and 100% at HC, including three intermediate ratios of energy applied at LC, as illustrated in Fig. 1.

Table 1. Fibre Fractions

Fractions	Mass proportion (%)	CSF (mL)	Mean fibre length (lw) (mm)
Primary pulp		567	1.78
A1 - Short fibres	12.1	265	0.39
A2 - Short fibres	5.4	175	0.40
LF - Long fibres	82.5	694	1.81

Pulp properties were evaluated on 60 g/m² handsheets prepared with a British sheet-mould former according to PAPTAC method C.4. Scott internal bond strength was measured according to TAPPI T833. Handsheet physical properties were measured according to PAPTAC methods D.34, D.9, and D.8. The optical instrument Fibre Quality Analyzer (OpTest Equipment, Canada, TAPPI T61 method) was used to test the mean fibre length and fibre coarseness. The carboxylic group content was determined by the Metrohm (Brinkmann) titrator and conductivity meter (Thermo Orion, model 150), using a conductometric technique. Scott internal bond strength was measured according to TAPPI T833. Zero-span tensile strength was measured according to PAPTAC standard D.27U (Pulmac Zero-span Method). Water retention value (WRV) was achieved according to TAPPI Useful method UM 256. The measurement of sedimentation volume of fines is determined as described by Marton and Robie (1969).

RESULTS AND DISCUSSION

The portion of fines can be as high as 80% of the accepted pulp after fractionation. The long fibre fraction consists of summer wood fibres with a small portion of spring wood fibres not broken during the refining process. The short fibre fraction consists mostly of spring wood fibres, which can contribute to bonding and surface properties, and primary fines such as flake-like particles which contribute to optical properties but little to bonding.

The development of the pulp characteristics during the refining process can be observed by studying the development of the tensile index while maintaining a constant fibre length. The specific refining energy transfer to the pulp to reach a fixed tensile index is the starting point of this investigation, as that information may prove useful in determining how and why energy ratios impact fibre development at any given tensile index. For a given tensile index, the range is quite large in terms of applied energy between the two refining methods, LC and HC (Fig. 2a). Thus, the tensile strength mainly depends on the consistency (Fig. 2b). In contrast, the fractionation itself does not cause a major difference in terms of refining energy for a given tensile index. These findings reinforce the conclusion that the amount of energy required to achieve a given tensile index depends heavily on the consistency and very little on fractionation. Compared to HC, LC reaches the same tensile index using less energy. For the same tensile index, fractionation enables only a small energy savings and has only a small influence on energy savings in both HC and LC. Therefore, the goal, here, is to maximise fibrillation (external or/and internal one) assuming no sharp decrease in the intrinsic strength (zero-span) of the fibres is suffered, as this can ultimately cause the fibre to break. This can surely be made possible by adequately controlling the refining process, by means of adjusting the energy ratios input.

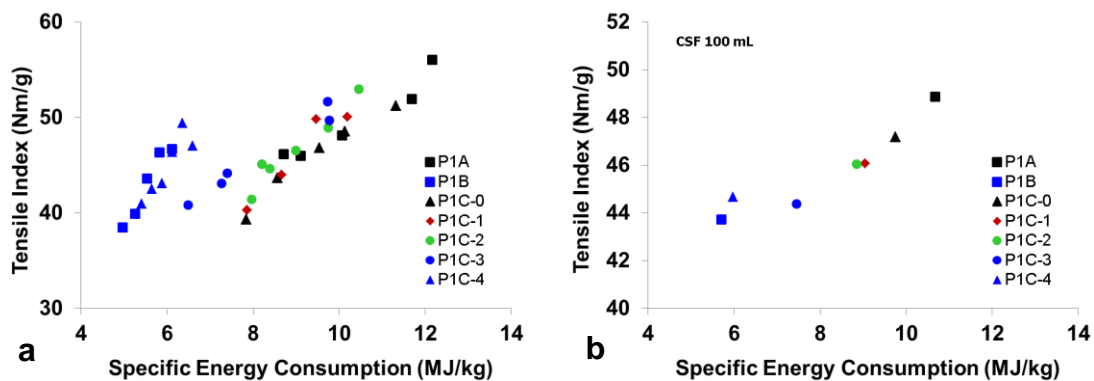

Fig. 2. Tensile index as a function of specific refining energy. (a) Refining curve for different freeness and (b) values interpolated at freeness 100 mL

What is the explanation for the tensile development differences when low consistency refining is used with or without fractionation? The first possibility to investigate is the fibre length, as shown in Fig. 3. Low consistency refining is often associated with fibre cutting when going from HCR towards LCR.

When fractionating is introduced, fibre length is largely maintained during low consistency refining. Fractionating helps maintain a higher fibre length when intermediary refining includes LC. Fractionating does not have as much of an influence on the fibre length for HC as it does for LC. Refining at LC is quite different from refining at HC in

that it takes place in an environment where there is plenty of water. In this quasi-liquid environment, fibre-to-bar contact is more frequent and the fines produced during LCR are present in the water too. At such consistency, the long fibres are mostly trapped and fines tend to flow around long fibres with water. They so receive less bar impacts than long fibres. On the other hand, fractionation removes fines, which has an influence on HC because under these conditions, the fines and short fibres absorb some of the forces generated during contact with the bar. Therefore, removing them will increase the force exerted on long fibres with each bar impact. Therefore, one would expect a large difference in LC and HC conditions, but the results of this study indicate the reverse: a huge benefit of fractionation in LC. A possible explanation could be the higher amount of long fibres in the plate gap at a given consistency. More fibres are impacted by the bar at the same time, which seems beneficial to the mean fibre length. The HCR gap at CSF 100 was in the range from 0.32 mm to 0.45 mm. In the case of LCR, the gap for whole pulp was from 0.13 mm to 0.18 mm. In other words, there was a gap range increase of +.05 mm when changing from whole pulp to long fibres only. This gap increase in LCR would subsequently reduce the intensity in LCR.

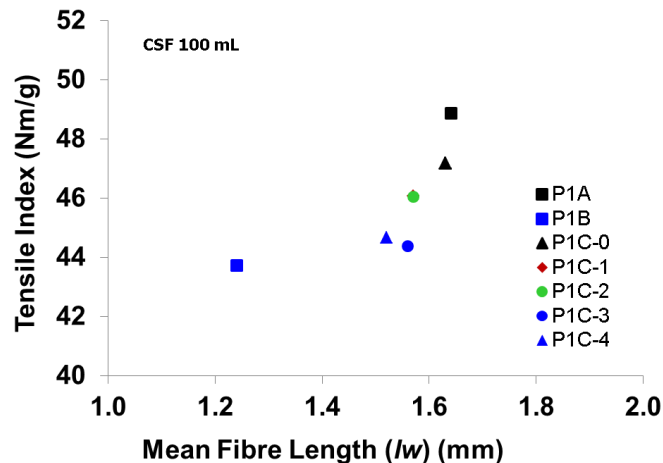

Fig. 3. Tensile index as a function of mean fibre length

However, even if the mean fibre length is maintained using LC with fractionation, the tensile index is not developed under either LC or HC conditions. Other factors must be taken into account. The effect of fractionation could be better surface development at HC or a higher generation of carboxylic acid groups, increasing bonding and subsequently the tensile index. During refining, delamination gives more fibrillation, which increases the specific surface area, and in turn gives more carboxylic group content in the fiber surface area. This is how increasing delamination gives rise to an increase in the specific surface area. Following the generation trend of accessible carboxyl groups makes it possible to see if there is more disposable outer surface and thus monitor the development of the surface area. However, in the same way, fractionation strongly reduces, in the course of our tests, the access to carboxylic groups' acid content on the fibre surface, by reducing the external delamination, which in turn reduces the available surface. The generation of carboxylic groups did not affect the tensile index, as shown in Fig. 4. There were no major differences due to the consistency. However, fractionation strongly reduced acid content on the fibre surface. Refining of whole pulp seems more

appropriate, but more carboxylic acid groups did not yield tensile improvement in this trial.

The tensile index of the R28 fraction can be related to the surface development of long fibres and therefore may represent an evaluation of bonding. As shown in Fig. 5, fractionation enables better bonding development when a part of the energy was applied at LC but had a negative impact at HC or when a large proportion of low consistency pulp was used. One can take advantage of this phenomenon to better develop the long fibres at LC before a final HC stage, leading to interesting energy reduction (Fig. 2) with acceptable tensile strength using an intermediate LCR/total energy ratio (PIC-1 and 2).

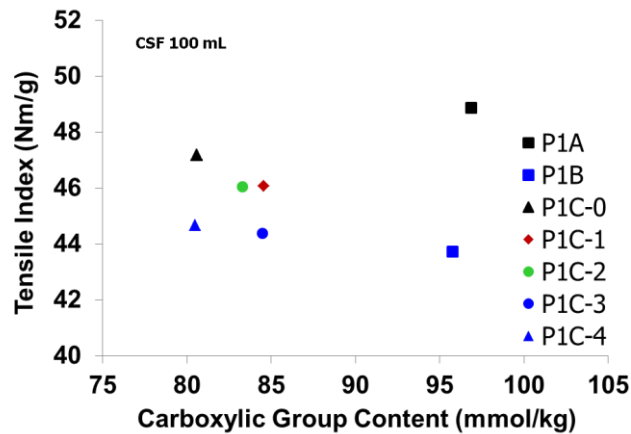

Fig. 4. Tensile index as a function of carboxylic acid group content

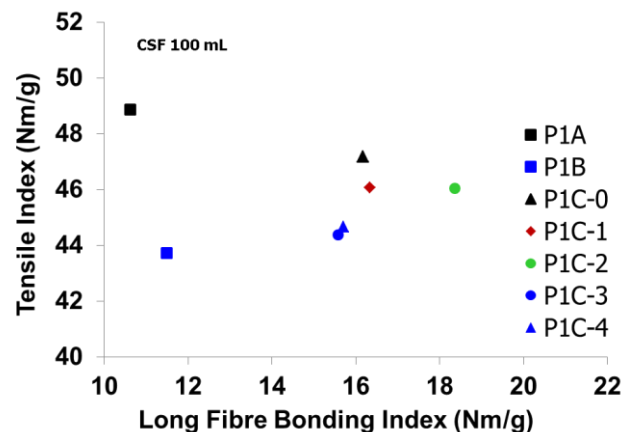

Fig. 5. Tensile index as a function of bonding index (tensile index of the R28 fraction)

Fractionation appeared to have a major impact on long fibre bonding development. In addition, the graph shows that during fractionation, increased consistency helped bonding development as well. Fractionation yielded greater fibre length when LC refining is used (Fig. 3), which gave higher tensile index, but the difference seems too small to explain the tensile improvement. The same bonding level gave a higher tensile index in HC conditions than it did in LCR. Otherwise fractionation greatly improved bonding elsewhere.

The washing effect also may have an impact on the tensile index, which may explain the results because addition of water will reduce the amount of extractives on the

fibre surface when extractives are taken away from the fibre surface, and more sites are released. These sites will help bonding.

During the refining process, bonding is developed through two different pathways: the delamination of the external fibre wall which can liberate the S2 layer to increase the fibrillation process or by internal delamination which increases the collapsibility of the fibre. The coarseness of long fibres indicates which pathway they would undergo. Also in the course of a previous publication on this study (Lemrini *et al.* 2014), when relating to fibre morphology, it was noticed that while in theory, when fibres are peeled off, and fibrillation is developed, coarseness decreases and bonding should subsequently increase. In our experimental circumstances, while the coarseness did not decrease significantly, bonding showed consistent improvement. It is assumed that the fractioning has a greater impact than the part attributed to coarseness decrease. Actually in that previous chapter, a general trend showed relatively little coarseness level change during any of the fraction processes. The degree of this change gradually decreased from long fibres toward the short ones. Since fractionation did help develop bonding index and provided no coarseness decrease, bonding seemed not to be related to coarseness, but to other more complex impacts. Figure 6 shows the coarseness of long and intermediate fibres. The figure clearly demonstrates that increasing the ratio of LC refining reduced the prevalence of the delamination process. Because fractionation helped develop bonding index and did not decrease coarseness, bonding seems unrelated to coarseness and instead related to other more complex factors.

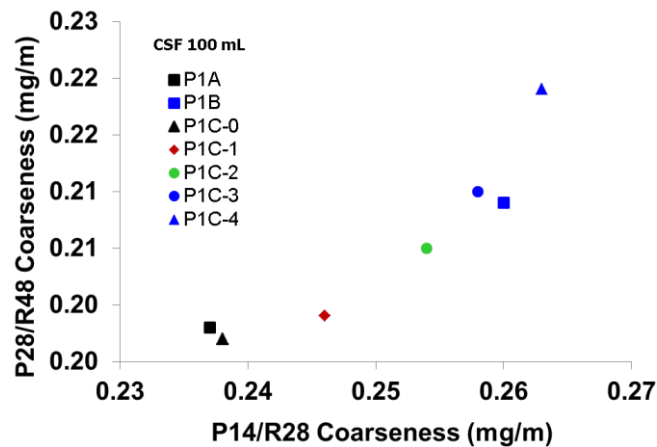

Fig. 6. P14/R28 and P28/R48 coarseness

The generation of fines and their quality can also impact bonding and the tensile index. Figure 7 shows that there was no huge difference in terms of fines quality or quantity. Low consistency refining did produce slightly more fines with roughly the same quality.

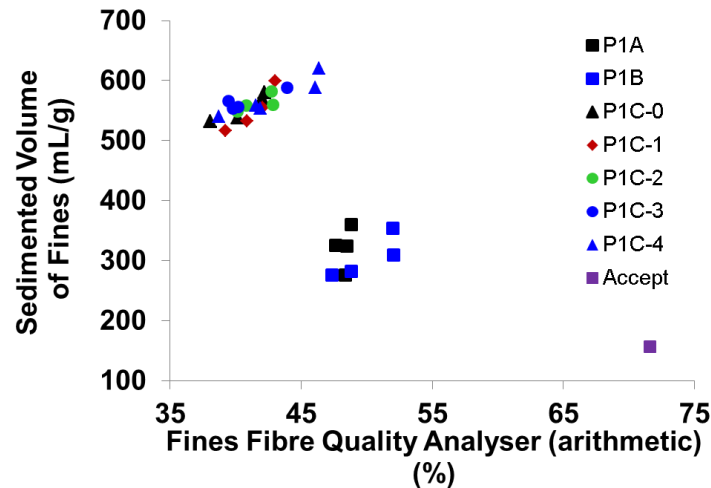

Fig. 7. Sedimented volume of fines as a function of fines content

Some other properties can help to confirm or understand the above analysis. They are presented in Table 2 for whole pulp and long fibres only (before fines are reintroduced to refined long fibres).

Table 2. Some Other Properties at CSF 100

	LCR/Total (%)	Tensile index (Nm/g)	Scott bond (with fines) (J/m ²)	Scott bond (long fibres only) (J/m ²)	WRV (with fines) (mL)	WRV (long fibres only) (mL)	Zero span (with fines) (km)	Zero span (long fibres only) (km)
P1A	0	48.9	110		206		11.5	
P1B	100	43.7	110		191		11.2	
P1C-0	0	47.2	126	118	206	255	12.5	11.5
P1C-1	3	46.1	125	107	205	236	12.4	12.2
P1C-2	6	46.0	140	112	204	240	12.4	11.9
P1C-3	21	44.4	138	111	210	240	12.4	11.4
P1C-4	40	44.7	113	92	197	184	12.1	10.4

Scott bond is a measure of internal cohesion. Its measurement helps assess the fibre internal bond (link) structure that holds fibres together. It can be attributed to both chemical bonds (*e.g.*, hydrogen bonds or surface fibrillation) and external physical bonds. Consistency has an impact on Scott bond only during LCR. Fractionation also has an impact. This impact increases with higher consistency of long fibres with somewhat of a maximum for P1C-2 corresponding to the peak observed for the bonding index. This confirms that a combination of LCR prior to HCR benefits fibre development.

The water retention value (WRV) level usually increases when the fines portion is added, as this new material mingles with long fibres and helps retain water. Theoretically, long fibres should retain less water before fines are added. However, WRV was maintained at the same level throughout the experimental long fibre testing even during interstage tests. If water was kept within this pulp mixture, it may well be that a more fibrillated surface, or one with micro-cracks in the wall, has the capacity to absorb this water. This may be an indication that the internal structure of the long fibres were loosened. In the course of refining, the fibres eventually develop micro-cracks in their structure, leading to internal fibrillation which increases flexibility, making them more absorbent. Thus, the supplementary fibrillation causes an increase in WRV as well. When

the fines are added, the WRV strongly decreases. The nature of the short material could explain this reduction. The fines fraction contains a high proportion of primary fines. That is why it is assumed that flake-like particles do not contribute to water absorption, being lignin rich materials. Overall, the water retention value is not significantly affected by either fractionation or consistency. The zero-span did not show large differences. That is why the intrinsic strength of the fibre seems to have been preserved.

The density variability during the process has a major impact on paper properties in general and especially on the tensile index. It indicates a change in the microstructure of wood which in turn changes the collapsibility of the fibres. Figure 8 shows that refining consistency changed this aspect and fractionation did not. For the whole pulp, the use of LCR led to increased coarseness of long fibres with a direct effect on sheet density. The refining of the long fibre fraction alone exhibited a different behaviour. The coarseness followed the same tendency but did not lead to a reduction in density. An improvement of internal delamination to achieve higher collapsibility should be considered.

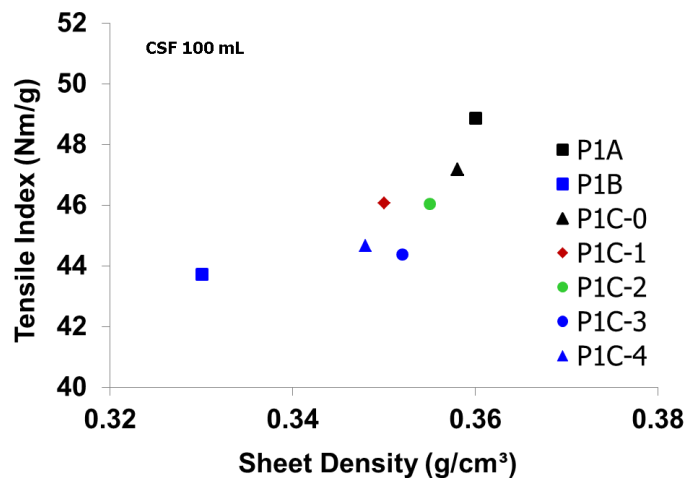

Fig. 8. Tensile index as a function of sheet density

CONCLUSIONS

1. Using a higher portion of energy amount of LC over HC tended to lower the tensile index at CSF 100, but some intermediate values exhibited a better response to global refining
2. Fractionation made it possible to use LCR to preserve fibre length and develop more extensive long fibre bonding.
3. Low consistency refining on the long fibre fraction reduces external delamination, as shown by higher coarseness for long fibres, and proportionally reduced the impact on sheet density. An explanation could be that a greater number or intensity of fibre-to-bar contacts helped increase internal delamination of the fibre structure. However, less external delamination with more internal changes did not change the final tensile index of the sheet. The net gain remains in terms of energy reduction.

ACKNOWLEDGMENTS

The authors are grateful for the support of the Natural Sciences and Engineering Research Council of Canada (NSERC) and the Government of Québec through its “Ministère de l’Enseignement supérieur, Recherche, Science et Technologie” (MERST).

REFERENCES CITED

- Andersson, S. (2011). “Low consistency refining of mechanical pulp- process conditions and energy efficiency,” Department of Natural Sciences, Thesis for the degree of Licentiate of Technology, Mid Sweden University, SE-851 70 Sundsvall, Sweden.
- Andersson, S., and Sandberg, C. (2011). “Mill experiences from a 72” LC refiner at Holmen Paper Braviken mill,” Proceedings of International Mechanical Pulping Conference, Xi'an, China, pp. 138-143.
- Corson, S. R., Wakelin, R. F., and Lloyd, M. D. (1995). “TMP furnish development strategies for contrasting fibre types,” Proceedings of International Mechanical Pulping Conference, Ottawa, ON, Canada, pp. 189-195.
- Eriksen, O., and Hammar, L. A. (2007). “Refining mechanisms and development of TMP properties in a low-consistency refiner,” Proceedings of International Mechanical Pulping Conference, Minneapolis, MN, United States, pp. 62-75.
- Ferluc, A., Lanouette, R., Bousquet, J.-P., and Bussi eres, S. (2010). “Optimum refining of TMP pulp by fractionation after the first refining stage,” *Appita Journal* 63(4), 308-314.
- Gorski, D., M orseeburg, K., Olson, J., Luukkonen, A. (2012). “Fibre and fines quality development in pilot scale high and low consistency refining of ATMP,” *Nordic Pulp & Paper Research Journal* 27(5), 872-881.
- Hafr en, J., Fernando, D., Gorski, D., Daniel, G., and Salomons, F. A. (2014). “Fiber- and fine fractions-derived effects on pulp quality as a result of mechanical pulp refining consistency,” *Wood Science and Technology* 48(4), 737-753. DOI: 10.1007/s00226-014-0636-1
- Hammar, L.  ., Htun, M., and Svensson, B. (1997). “A two-stage refining process to save energy for mechanical pulps,” Proceedings of International Mechanical Pulping Conference, Stockholm, Sweden, pp. 257-262.
- Lemrini, M. M., Lanouette, R., and Michaud, G. (2013). “Merging interstage fractionation and low consistency advantages during TMP refining process: Energy consumption and paper’s properties improvement,” *PACWEST Conference Proceedings*, Kamloops, BC.
- Lemrini, M. M., Lanouette, R., and Michaud, G. (2014). “Merging interstage fractionation and low consistency advantages during TMP refining process: The fiber development,” Proceedings of International Mechanical Pulping Conference, Helsinki, Finland, on CD-ROM.
- Marton, R., and Robie, J. D. (1969). “Characterization of mechanical pulps by a settling technique,” *TAPPI Journal* 52(12), 2400-2406.
- Mou, H., Iamazaki, E., Zhan, H., Orblin, E., and Fardim, P. (2013). “Advanced studies on the topochemistry of softwood fibres in low-consistency refining as analyzed by FE-SEM, XPS, and ToF-SIMS,” *BioResources* 8(2), 2325-2336.

- Ouellet, D., Beaulieu, S., Roberts, N., Rompre, A., and Gooding, R. (2003). "Comparison of slotted screen and hydrocyclone fractionation systems for the manufacture of newsprint TMP," *Pulp and Paper Canada* 104(12), 76-82.
- Sabourin, M. (2007). "Minimizing TMP energy consumption of chip pre-treatment, RTS and multiple stage low consistency refining," Proceedings of International Mechanical Pulping Conference, Minneapolis, MN, United States, pp. 839-893.
- Sabourin, M., Antensteiner, P., and Luukkonen, A. (2011). "Aggressive low consistency refining in thermomechanical pulping: Energy consumption and fibre development," Proceedings of International Mechanical Pulping Conference, Xi'an, China, pp. 248-252.
- Sandberg, C., Nilsson, L., and Nikko, A. (1997). "Fibre fractionation - A way to improve paper quality," Proceedings of International Mechanical Pulping Conference, Stockholm, Sweden, pp. 167-171.
- Sandberg, C., Sundström, L., Andersson S. and Nelsson E. (2011). "New TMP line improves pulp quality and reduces energy consumption," Proceedings of International Mechanical Pulping Conference, Xi'an, China, pp. 472-475.
- Wakelin, R. F., Jackman, J. K., and Bawden, A. D. (1999). "Changes in mechanical pulp fibre cross-sectional dimension distributions caused by screens, hydrocyclones and reject refining," 53rd Appita Annual Conference, Proceedings, Vols 1 and 2, Rotorua, New Zealand, pp. 211-220.

Article submitted: September 8, 2014; Peer review completed: October 25, 2014; Revised version received and accepted: December 11, 2014; Published: December 17, 2014.