

Influence of the Enzyme Addition Point on Recycled Industrial Pulp Properties

Mirtha G. Maximino,^{a,*} María C. Taleb,^a and Ana M. Adell^a

The influence of the enzyme addition point on fiber properties was analyzed by treating two industrial recycled pulp samples – with and without industrial refining – with a mixture of cellulases and hemicellulases. The effects of the enzyme treatment variables – enzyme dosage, time, and consistency – on the fiber properties were studied. The aim of this work was to improve the drainability and the recovery of the strength properties of recycled fibers. The properties of the pulps treated enzymatically and refined in a PFI mill were also evaluated. According to the statistical analysis, opposite effects on drainability were obtained by varying pulp consistency, enzyme dosage, and enzyme application point (*i.e.*, before or after the industrial mechanical treatment). Drainability and strength properties increased when the enzymatic treatment was applied to the pulp without industrial refining, whereas no improvement was observed for pulp with industrial refining.

Keywords: Industrial recycled pulp; Enzyme addition point; Cellulases and hemicellulases; Pulp refining; Drainability; Strength properties

Contact information: a Instituto de Tecnología Celulósica. Facultad de Ingeniería Química. Universidad Nacional del Litoral. Santiago del Estero 2654 – (S3000AOJ) Santa Fe, Argentina. Tel-fax: +54 342 452 0019; *Corresponding author: maximino@fiq.unl.edu.ar

INTRODUCTION

During the last several decades, recycled paper consumption as a raw fiber resource for the manufacture of various paper and paperboard grades has increased worldwide. Annual consumption of recycled fibers has grown 3 to 4% per year, reaching a recovered paper production of about 207 million tons in 2010 (Forestat 2010).

The use of recycled fibers in paper production has some disadvantages compared to virgin fibers, due to changes in the pulp that take place during the successive re-use cycles. Some of the disadvantages of recycled fibers are their lower strength properties and drainability. These are particularly attributed to the hornification that results from the successive dryings and wettings of the recycled fibers, which lose water sorption capacity, resulting in a decrease in water retention value. Hornified fibers become more rigid and form less dense sheets with less and weaker inter-fiber bonding (Bawden and Kibblewhite 1997). Refining, the typical operation used to recover the strength properties of recycled fibers, can decrease pulp drainability drastically, thus decreasing drainage speed and lowering paper machine production. Fiber hornification causes the recycled fiber to fracture during refining, thus generating fines.

Some studies have reported pulp drainage enhancement by applying cellulases to recycled fibers. Sarkar *et al.* (1995) showed improvements in paper machine runnability by applying enzymes plus a polymer. The potential of cellulase enzymes has also been demonstrated in reducing the energy requirement for pulp refining, in improving machine

runnability, and in controlling stickies when using recycled fibers (Bajpai 2010). One of the first works was carried out by Pommier *et al.* (1989) on an OCC (Old Corrugated Container) pulp; the authors provided the clearest evidence of strength improvement on secondary fibers by treating them with low concentrations of cellulases and mixtures of cellulases and hemicellulases. As a result, pulp drainability was increased without a loss of strength properties. When mechanical refining preceded the enzymatic treatment, better properties were obtained, at the same drainability, than for the untreated pulp.

Following this research, Bhardwaj *et al.* (1995) evaluated different types of enzymes, *e.g.* Pergalase (a mixture of cellulase and hemicellulase) and Maxazyme (a cellulase) and observed substantial drainage improvements in the treated pulps with respect to the control (*i.e.*, without enzyme treatment). Most of the strength properties of the recycled OCC were maintained with the addition of 0.1% of Pergalase for 45 min, or 0.2% of the enzyme for 30 min. A treatment time longer than 30 min with an enzyme dose of 0.2% produced deterioration in strength properties.

Jackson *et al.* (1993) showed that cellulases and hemicellulases adhered preferentially to fines rather than to long fibers of a kraft pulp, and this effect protects the long fibers from the excessive degradation by the cellulases. This is the mechanism proposed by the authors for the observed improvements with drainage without compromising physical strength properties. Both Jackson and other authors (Jackson *et al.* 1993; Stork *et al.* 1995; Eriksson *et al.* 1998) concluded that the enzymatic treatment would be an appropriate way to improve the recycled pulp drainability. In an OCC application some significant energy savings were measured (Kim *et al.* 2006), though in some cases, losses in paper strength properties have been observed (Michalopoulos *et al.* 2005).

Maximino *et al.* (2011) analyzed the effects of enzymatic treatment with Pergalase A40 (mixture of cellulases and hemicellulases) on a recycled unbleached industrial pulp. The authors concluded that the enzymatic treatment resulted in drainability improvements for all cases, with the highest values attained at 10% consistency and 5.2 IU/g of enzyme dose. Furthermore, the increase in apparent sheet density, verified with the enzymatic treatment and subsequent refining in PFI mill, could be considered one of the primary effects of the enzymatic treatment. Bajpai *et al.* (2006) conducted laboratory and process-scale studies with mixtures of cellulase and hemicellulase enzymes for reducing the refining energy requirement of different types of pulps which included virgin pulp and recycled pulp fibers.

The aim of this work was to improve the drainability and the strength properties recovery of recycled fibers. The effects of the enzyme treatment variables – enzyme dosage, time, and consistency – on the properties of the fibers were studied. The properties of pulps treated enzymatically and refined in PFI mill were also evaluated. The influence of the Pergalase addition point on the properties of the fibers was evaluated on two enzymatically treated pulp samples, one obtained from the thickener output – before industrial refining, and the other from the output of the refiner after industrial refining.

EXPERIMENTAL

Materials

Pulp

The recycled industrial pulp, constituted of 56.5% old corrugated containers (OCC), 37.5% kraft liners, and a low percentage (6%) of printing and writing papers

(white office), was provided by Papelera Entre Ríos (Argentina). Figure 1 shows the recycle mill unit operations in which pulp samples were obtained. One sample was obtained from the thickener output (before industrial refining - BIR pulp). The other sample was from the output of the refiner (after industrial refining - AIR pulp).

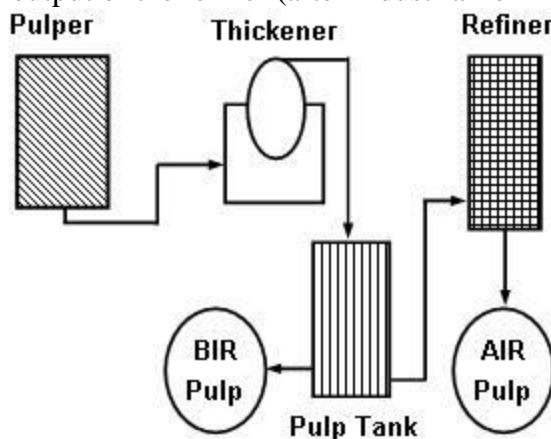

Fig. 1. Schematic representation of the extraction points of pulps at the industrial plant. BIR pulp indicates the pulp before industrial refining and AIR pulp indicates the pulp after industrial refining

Enzyme

The enzyme used for this study was Pergalase A40, a commercial product provided by Genencor International, Inc. It is a blend of enzymes, mainly cellulases and hemicellulases, obtained from *Trichoderma longibrachiatum*, according to the information of the manufacturer.

The enzymatic activity was tested by the dinitrosalicylic acid method (DNS) by measuring the generated reducing sugars according to the standards of the Commission of Biotechnology, IUPAC (Ghose 1987). Cellulase activities were tested using carboxymethyl cellulose (CMC) and Whatman N° 1 filter paper (FP) as the substrates for 30 and 60 min, respectively, at 45 °C and pH 6. Xylanase activity was determined using birch wood xylan (XYL) as the substrate for 30 min at 45 °C, adjusted to pH 6 with 0.1 M phosphate buffer (Bailey *et al.* 1992).

One international enzyme unit (IU) was defined as the amount of enzyme necessary for the production of 1 μmol of reducing sugar per min under the tested conditions. The results of the enzymatic activities, in IU mL^{-1} of solution, were:

- $\text{CMC}_{\text{ase}} = 2,624 \text{ IU mL}^{-1}$
- $\text{FP}_{\text{ase}} = 27.4 \text{ IU mL}^{-1}$
- $\text{XYL}_{\text{ase}} = 267.5 \text{ IU mL}^{-1}$

These results indicated that this enzyme solution has a significant cellulase activity.

Pulp treatments

The received pulps (BIR and AIR) were cleaned in a Sommerville sieve, thickened with a 100-mesh sieve and then stored in plastic bags at 4 °C. They were named PB and PA pulps, the drainabilities of which were 430 and 405 mL CSF, respectively (Fig. 2).

A 2^3 factorial design was applied to analyse the enzymatic treatments on the PB and PA pulps (Fig. 2). The three factors used in this study were the following: 5 and 10% consistency (*C*), 30 and 90 min of treatment time (*T*), and 2.6 and 5.2 IU.g^{-1} of enzyme charge/o.d. pulp (*E*). To estimate the effects of each factor and their interactions, the

experimental results obtained from the factorial design were analyzed using statistical software with a 95% of confidence level.

Enzymatic treatments were performed at pH 6 and 45 °C in a stainless steel batch reactor with indirect heating and mixing. After the enzymatic treatment, the pulp was filtered on a Büchner funnel using a laboratory vacuum pump. The reaction was stopped by pouring the slurry into sodium hydroxide solution (pH 12) and mixing it for 15 min at room temperature. The pulp was then washed to guarantee complete alkali removal. The reducing sugars released during the enzyme treatment were analyzed in the residual liquor, using the DNS method to determine the enzymatic hydrolysis extent (Ghose 1987).

Both the untreated and the enzymatically treated pulps were refined in laboratory PFI mill at 1,000 revolutions (TAPPI 248 sp-00) (Fig. 2). Energy consumption was measured on a wattmeter inserted in the original control panel of the PFI mill. The no-load energy of refining was obtained by running the mill with the load removed before and after each pulp refining. Although these conditions do not match, in absolute value, those used industrially, they could be considered valid at a relative level.

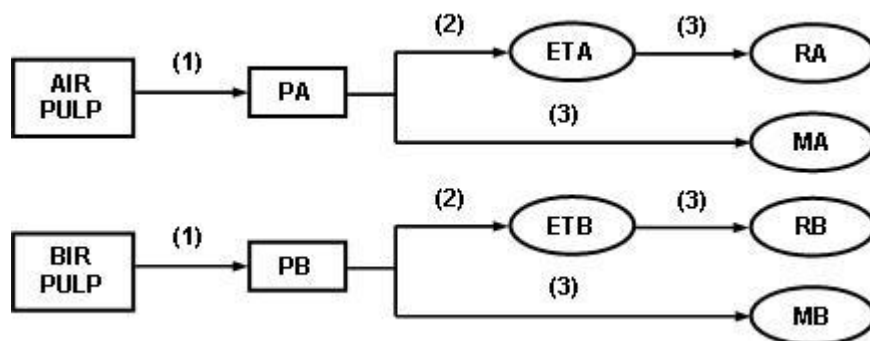

Fig. 2. Experimental procedure of industrial pulps in the laboratory. (1) Cleaning and thickening, (2) enzymatic treatments and (3) PFI mechanical refining

Pulp evaluation

Fines analysis was performed with a dynamic drainage jar (*i.e.*, Britt jar) according to the TAPPI Test Method T 261 cm-00, and the Canadian standard freeness (CSF) value was measured by SCAN-C21:65. Laboratory handsheets were produced according to the SCAN-C26:76 method, and were tested for physical properties by TAPPI T 220 sp-01 for light-scattering coefficient, apparent density, and tensile index, and by SCAN-PB1:73 for tear index.

RESULTS AND DISCUSSION

Effects of the Enzymatic Treatment

Factorial design

The significant effects of enzyme treatment variables on the properties for both pulps were determined through statistical analysis. Table 1 presents the effects of factor variables and their interactions with the response variable properties (*i.e.*, reducing sugars, tear index, and drainability) with p-values lower than 0.05, which indicates that they are significantly different from zero at the 95 % confidence level.

Table 1. Effects of the Factorial Design for the Studied Pulps

Pulps	Property	p-values					
		T ^a	C ^b	E ^c	(T x C) ^d	(C x E) ^e	(T x E) ^f
ETB	Reducing sugar	0.0009	0.0396	0.0029	0.1282	0.9845	0.0095
	Tear index	0.0009	0.0123	0.0061	0.0188	0.1056	1.0000
	Drainability	0.1552	0.0316	0.0012	0.1271	0.0074	0.7048
ETA	Reducing sugar	0.0003	0.0744	0.0012	0.0265	0.1922	0.1112
	Tear index	0.0022	0.0602	0.0664	0.2447	0.0900	0.5577
	Drainability	0.3528	0.0122	0.0379	0.2821	0.8440	0.3528

^a treatment time, ^b pulp consistency, ^c enzyme charge, ^{d, e} and ^f factor interactions

Figure 3 shows the main effects of the factors on pulp drainability (mL CSF) for pulps PA (with industrial refining) and PB (without industrial refining). For each pulp, the consistency (C) and enzyme charge (E) showed opposite effects on drainability. For pulp PB, the drainability increased when the factors changed from lower to higher values, with the effects being more noticeable for the enzyme charge variation. On the other hand, drainability decreased with higher consistency and higher enzyme charge after industrial refining. This showed the influence of the application point of this enzyme when it is used as an agent for improving drainage of a recycled pulp.

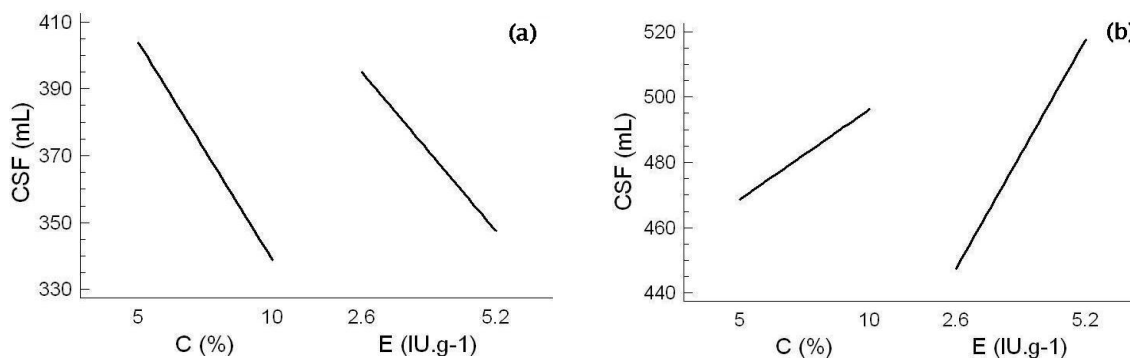

Fig. 3. Significant effects on Drainability (mL CSF), for all of the enzymatic treatments of the pulps: (a) PA and (b) PB.

Residual liquor

Figure 4 shows that the production of reducing sugar was a function of the enzyme charge for pulps PA and PB. When comparing both pulps, for all the enzymatic treatment conditions, pulp PA showed more reducing sugars, with the greatest effect appearing at the longest treatment time and 5.2 IU.g⁻¹ enzyme dosage. Furthermore no differences in sugar production were observed for both application points and for both consistencies. From the statistical point of view (Table 1), the variables of the enzyme treatment showed significant effects on reducing sugar production for both pulps. Pulp PA would present morphological changes in its fibers, such as external and internal fibrillation, and generation of fines (high specific surface), making the fibers more susceptible to enzymatic hydrolysis. These changes were not observed for pulp PB.

Tear index

The tear index variation as a function of enzyme charge is shown in Fig. 5. This strength property was the physical property most negatively affected by the enzymatic treatment. The variation tendency, similar for both pulps, manifested itself as two well-marked levels: a lower one, corresponding to the pulp PA, which initially showed a 39 % reduction in tear strength, and the upper one, corresponding to pulp PB.

For both consistencies and with the shortest treatment time (30 min), the tear index reduction was similar for both pulps, and lower than 7 % in all cases. With the longest treatment time, on the other hand, there was a tear strength loss of about 15 %.

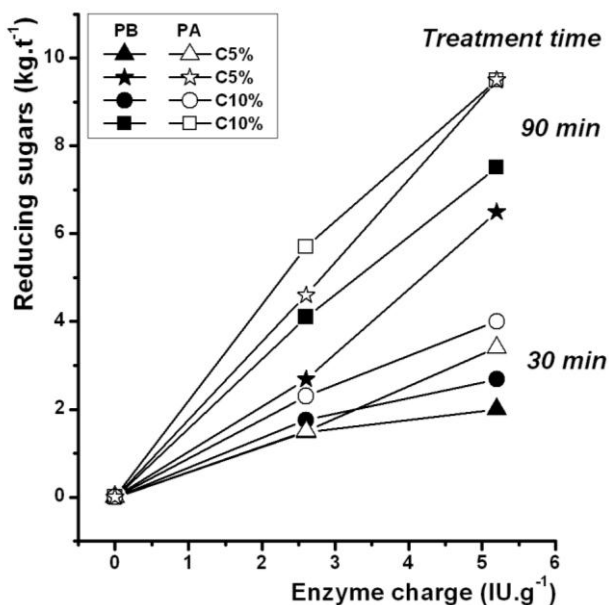

Fig. 4. Effect of enzyme charge on the reducing sugars released. (C: pulp consistency)

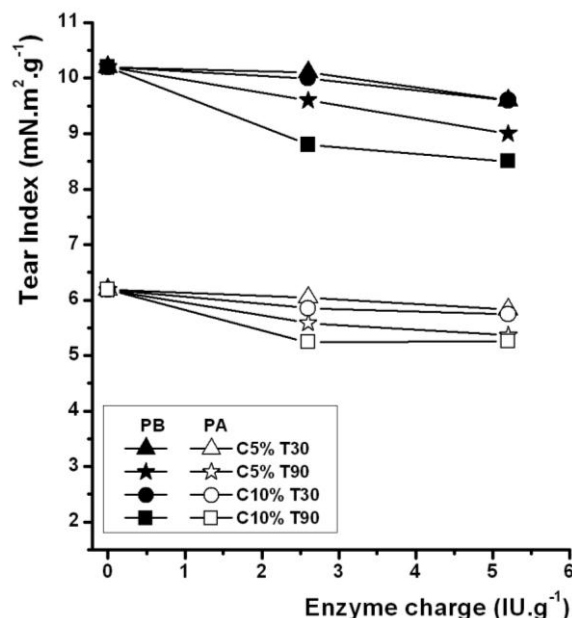

Fig. 5. Evolution of tear index with enzyme charge. (C: pulp consistency and T: treatment time)

Effects of Enzymatic and Mechanical Treatments

Tables 2 and 3 show the treatment conditions and properties of pulps PB and PA.

Table 2. Properties of PB Pulp Treatments

PB			Enzymatic Treatments				Refining treatments (1000 rev PFI)			
C (%)	T (min)	E (UI.g ⁻¹)	CSF (mL)	Fines (%)	Apparent Density (g.cm ⁻³)	Tensile Index (N.m.g ⁻¹)	CSF (mL)	Fines (%)	Apparent Density (g.cm ⁻³)	Tensile Index (N.m.g ⁻¹)
0	0	0	430	15.3	0.524	38.0	290	16.0	0.562	47.2
5	30	2.6	460	15.4	0.541	38.1	300	19.2	0.581	52.8
10	30	2.6	450	12.5	0.538	39.6	335	20.8	0.578	50.5
5	90	2.6	450	15.2	0.535	38.3	345	17.2	0.552	47.4
10	90	2.6	430	16.1	0.537	39.7	300	19.0	0.592	54.6
5	30	5.2	480	16.7	0.531	39.9	415	17.8	0.592	54.9
10	30	5.2	565	15.3	0.539	36.7	360	16.3	0.582	53.9
5	90	5.2	485	17.0	0.541	39.5	305	17.4	0.576	54.4
10	90	5.2	540	17.6	0.547	37.7	345	18.8	0.618	54.4

Table 3. Properties of PA Pulp Treatments

PA			Enzymatic Treatments				Refining treatments (1000 rev PFI)			
C (%)	T (min)	E (U.l.g ⁻¹)	CSF (mL)	Fines (%)	Apparent Density (g.cm ⁻³)	Tensile Index (N.m.g ⁻¹)	CSF (mL)	Fines (%)	Apparent Density (g.cm ⁻³)	Tensile Index (N.m.g ⁻¹)
0	0	0	405	19.2	0.551	38.0	275	22.7	0.565	45.4
5	30	2.6	410	17.8	0.547	34.2	235	25.0	0.601	45.1
10	30	2.6	380	17.2	0.566	36.3	165	29.2	0.592	41.0
5	90	2.6	450	17.5	0.579	37.3	230	23.7	0.606	38.7
10	90	2.6	340	21.9	0.579	35.5	140	28.1	0.613	40.1
5	30	5.2	395	18.7	0.561	34.9	245	22.1	0.605	44.0
10	30	5.2	335	18.3	0.574	33.7	170	26.5	0.621	41.4
5	90	5.2	360	11.2	0.561	33.1	192	28.4	0.616	40.3
10	90	5.2	300	22.0	0.585	34.7	132	30.6	0.618	38.1

Enzymatically-treated pulps were refined at 1,000 revolutions in the PFI mill. Figure 6 shows the values of drainability and tensile index for the evaluated pulps. For pulp PB, the enzymatic treatment led to improvements in drainability and tensile strength (Fig. 6b).

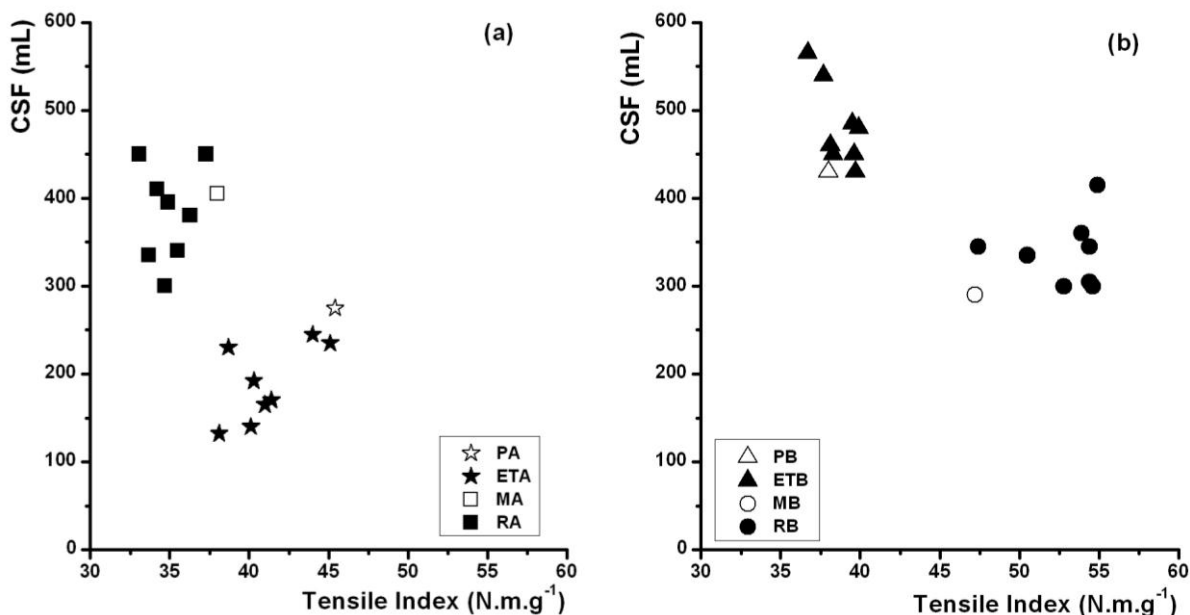
**Fig. 6.** Evolution of drainability (mL CSF) and tensile index, (a) Pulp PA and (b) Pulp PB

Similar behavior was observed when applying 1,000 revolutions of PFI to the enzyme-treated pulps. In almost all cases, pulp PA (Fig. 6a) showed lower drainability and tensile strength. Only an 11 % improvement was observed for pulp drainability, while pulp tensile strength was maintained when using the following conditions: 2.6 IU.g⁻¹ enzyme charge, 5 % pulp consistency, and 90 min treatment time. A drainability decrease would indicate that a certain beating effect was produced by the action of the

enzyme, which does not result in a recovery of the strength property (tensile index) with respect to the PB pulp.

Figure 7 shows the evolution of tensile index with apparent sheet density. For pulp PB (Fig. 7b), little improvements in apparent density and tensile strength were attained with the enzymatic treatment. The mechanical treatment with the PFI led to strength improvements of 15 % and a marked apparent sheet density increment regarding the reference pulp. Comparatively, pulp PA (Fig. 7a) with enzymatic treatment and refining in the PFI mill showed higher densification than pulp PB, but with lower tensile strength values. Also in this case, for pulp PA the material susceptible to hydrolysis was more accessible, resulting in a higher production of reducing sugars, mainly at higher enzyme charge, as was shown in Fig. 4.

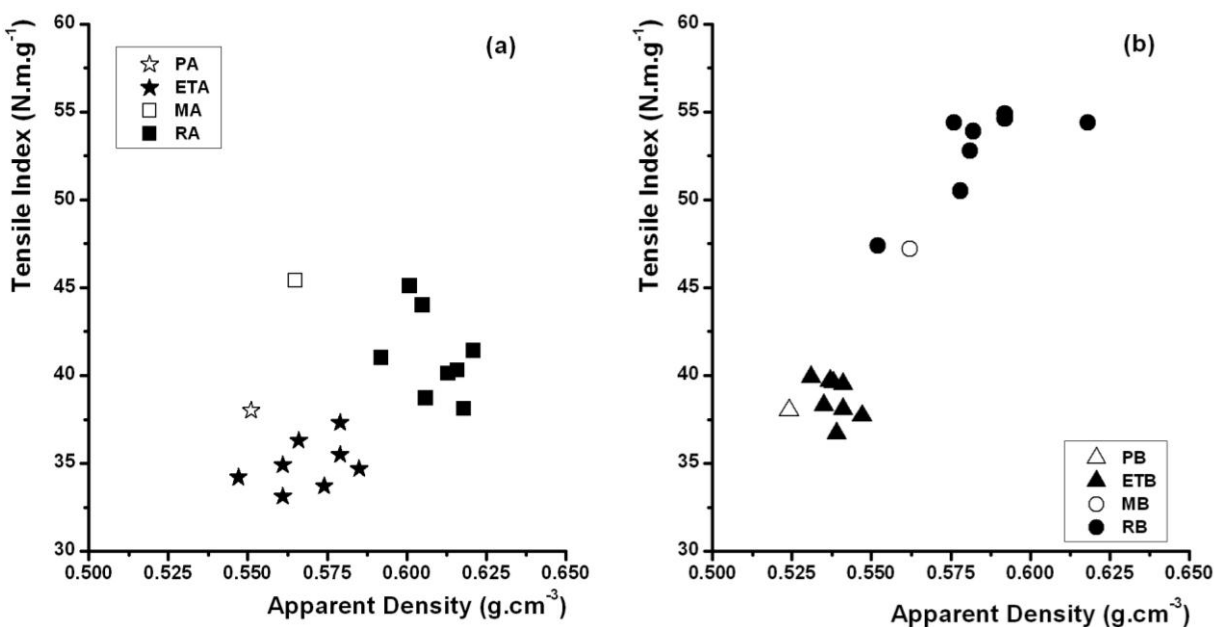

Fig. 7. Evolution of tensile index and apparent density, (a) Pulp PA and (b) Pulp PB

If it is considered that refining improves pulp strength properties, the enzymatic treatment would produce that effect on pulp PB. This behavior was not observed, however, for pulps PA, since lower tensile strength and drainability values were observed for all of the treatments. In these cases, the enzymatic treatment was not sufficient to improve the inter-fiber bonding.

The factors affecting tensile strength are primarily the RBA (relative bonded area) and the SBS (specific bond strength), and secondly the length and the intrinsic strength of the fibers. Pulps PA had higher densification and lower light scattering coefficient (results not showed), which indicated an increase in RBA. However, the tensile strength of pulps PA was lower, which would suggest a reduction of the specific strength of the bonding.

The apparent sheet density increase, as observed for both pulps, would be one of the primary effects of the enzymatic treatment. Wong *et al.* (1999), working with xylanases, attributed higher sheet densification to an increase in treated fiber flexibility via a mechanism that differs from those associated to the mechanical refining.

The application of the enzyme to pulp PA reduced the drainability, as if it were an “enzymatic refining”, though it did not improve the inter-fiber bonding. Pulp fine content

played an important role, as shown in Fig. 8, where the tensile index versus the fines content are plotted for the analyzed pulps. Pulps PA presented higher fines content (Fig. 8a) and higher densification (Fig. 7a) for all treatments – with enzyme and enzyme plus PFI refining, but their tensile index values were lower than the tensile index obtained for pulp PB (Fig. 8b). This would suggest that the enzymes could be changing the fiber surface either physically or chemically, leading to a reduced degree of inter-fiber bonding. According to Wong *et al.* (1999), additional assays such as intrinsic strength and flexibility would be necessary to further explain the enzyme action on recycled fibers.

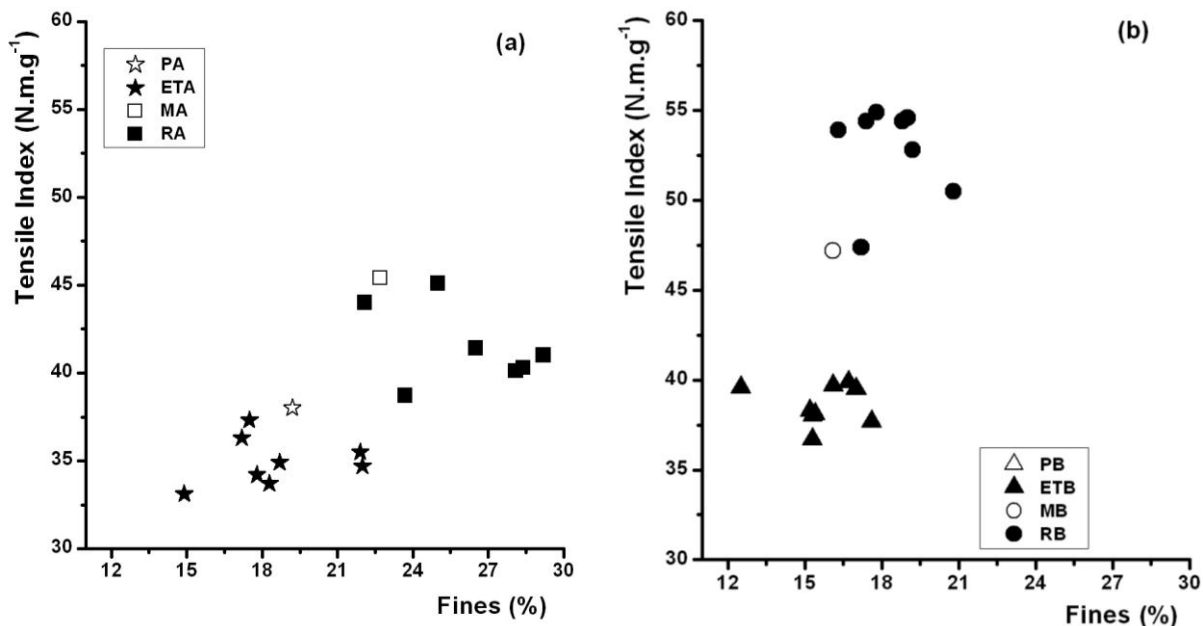

Fig. 8. Evolution of tensile index and fine contents, (a) Pulp PA and (b) Pulp PB

CONCLUSIONS

1. This work showed the effect of the enzyme application point on the properties of a recycled unbleached industrial pulp with and without refining in the recycle mill.
2. Statistical analysis proved that the variation of the pulp consistency and enzyme dosage factors had opposite effects on drainability, depending on the enzyme application point (*i.e.*, before or after the industrial mechanical treatment).
3. Improvements in drainability were observed for pulp PB (**without industrial refining**), with the highest gain obtained with the following conditions: 10 % pulp consistency and 5.2 IU g⁻¹ of enzyme charge.
4. Increases in apparent sheet density, tensile index, and fines contents were obtained in most cases for post enzymatic treatment (enzyme) and for all the combined treatments (enzyme plus PFI).
5. Enzymatic treatment for pulp PA (**with industrial refining**) neither increased drainability nor increased bonding, yielding lower tensile strength than the

reference pulp. The mechanical treatment of these pulps in a PFI mill showed the lowest tensile values with respect to the reference pulp, despite the greater sheet densification and fine content. It would seem that the enzymes, in this case, would be changing the fiber surfaces, either physically or chemically, thus leading to a decrease in inter-fiber bonding.

6. It was concluded from the results obtained that the application of this enzyme led to improvements in pulp drainability and tensile strength in the absence of mechanical treatment (*i.e.*, refining) in the recycle mill.

ACKNOWLEDGMENTS

This work was carried out with funds from the Agencia Nacional de Promoción Científica y Tecnológica (ANPCyT) and the Universidad Nacional del Litoral. The authors want to thank International Genencor Co. for the Pergalase A40 enzyme, Papelera Entre Ríos S. A. for the recycled OCC pulps, and Juliana Maccarone, a chemistry student, for her important collaboration in the experimental work.

REFERENCES CITED

- Bailey, M. J., Biely, P., and Poutanen K. J. (1992). "Interlaboratory testing of methods for assay of xylanase activity," *J. Biotechnol.* 23(3), 257-270.
- Bajpai, P. (2010). "Solving the problems of recycled fiber processing with enzymes," *BioResources* 5(2), 1311-1325.
- Bajpai, P., Mishra, S. P., Mishra, O. P., Kumar, S., and Bajpai, P. K. (2006). "Use of enzymes for reduction in refining energy - Laboratory studies," *Tappi J.* 5(11), 25-32.
- Bawden, A. D., and Kibblewhite, R. P. (1997). "Effect of multiple drying treatments on kraft fiber walls," *J. Pulp Paper Sci.* 23(7), J340-J346.
- Bhardwaj, N. K., Bajpai, P., and Bajpai, K. (1995). "Use of enzymes to improve drainability of secondary fibers," *Appita J.* 48(5), 378-380.
- Eriksson, L. A., Heitmann, J. A., and Venditti, R. A. (1998). "Freeness improvement of recycled fibers using enzymes with refining," ACS Symp. Ser. 687, pp. 41-54.
- Forestat. (2010). <http://faostat.fao.org/> Forestry.
- Ghose, T. K. (1987). "Measurement of cellulase activities," *Pure & Appl. Chem.* 59(2), 257-268.
- Jackson, L. S., Heitmann, J. A., and Joyce, T. W. (1993). "Enzymatic modifications of secondary fiber," *Tappi J.* 76(3), 147-154.
- Kim, H.-J., Jo, B.-M., and Lee, S.-H. (2006). "Potential for energy saving in refining of cellulase-treated kraft pulp," *J. Ind. Eng. Chem.* 12(4), 578-583.
- Maximino, M. G., Taleb, M. C., Adell, A. M., and Formento, J. C. (2011). "Application of hydrolytic enzymes and refining on recycled fibers," *Cell. Chem. Tech.* 45(5-6), 397-403.
- Michalopoulos, D. L., Gosh, D., and Murdoch, B. (2005). "Enhancement of wood pulps by cellulase treatment," Presentation 43-2, Engineering, Pulping and Environmental Conference Proceedings, TAPPI Press, Atlanta, Georgia, USA.

- Pommier, J. C., Fuentes, J. L., and Goma, G. (1989). "Using enzymes to improve the process and the product quality in the recycled paper industry," *Tappi J.* 71(6), 187-191.
- Sarkar, J. M., Cospe, D. R., and Hartig, E. J. (1995). "Applying enzymes and polymers to enhance the freeness of recycled fiber," *Tappi J.* 78(2), 89-95.
- Stork, G., Pereira, H., Wood, T. M., Düsterhöft, E. M., Toft, A., and Puls, J. (1995). "Upgrading recycled pulps using enzymatic treatment," *Tappi J.* 78(2), 79-88.
- Wong, K. K. Y., and Mansfield, S. D. (1999). "Enzymatic processing for pulp and paper manufacture – A review," *Appita J.* 52(6), 409-418.

Article submitted: Article submitted: August 9, 2012; Peer review completed: October 29, 2012; Revised version received and accepted: January 9, 2013; Published: January 15, 2013.