

Comparative Research on the Structure, Chemistry, and Physical Properties of Turkey Oak and Sessile Oak Wood

Iulia Deaconu, Mihaela Porojan, Maria Cristina Timar, Bogdan Bedeleian, and Mihaela Campean *

The objective of this research was to establish comparatively some relevant features of Turkey oak and sessile oak wood, in order to better understand the drying behavior of these species. The analyzed samples were obtained from freshly harvested trees of the same age, originating from the Southern Sub-Carpathians. The microscopic analysis revealed that Turkey oak has larger earlywood pores than sessile oak. In heartwood, they are partly filled with tyloses for both species. The macroscopic analysis showed that Turkey oak wood has a much lower proportion of heartwood (only 50%) compared to sessile oak (90%). The comparative FTIR analysis of the two species showed similar qualitative chemical composition, but also some differences between sapwood and heartwood regarding the relative proportion of the main constituents, and very likely in the structure of lignin. High amounts of extractives were found in Turkey oak sapwood (5.34% in cold water, 7.77% in hot water, and 21.60% in NaOH 1%), close to the values obtained in sessile oak heartwood. The research also revealed that the Turkey oak sapwood and heartwood have statistically similar values of oven-dry density, shrinkage coefficient, fiber saturation point, while in sessile oak, the values are clearly higher in the heartwood.

DOI: 10.15376/biores.18.3.5724-5749

Keywords: Turkey oak; Sessile oak; Sapwood; Heartwood; Color; Extractives; Density; Shrinkage; Fiber saturation moisture content

Contact information: Transilvania University of Brasov, Faculty of Furniture Design and Wood Engineering, Universitatii Str. Nr. 1, 500068 Brasov, Romania;

* Corresponding author: campean@unitbv.ro

INTRODUCTION

Turkey oak (*Quercus cerris* L.) and sessile oak (*Quercus petraea* (Matt.) Liebl.) are deciduous hardwood species with a ring-porous structure. Turkey oak is native to southern Europe and Asia Minor (De Rigo *et al.* 2016). Sessile oak is commonly found across most of Europe, reaching northwards to the southern Scandinavian peninsula, and southwards to the northern part of the Iberian peninsula, southern Italy, the Balkan peninsula, and Turkey (<https://joint-research-centre.ec.europa.eu/european-atlas-forest-tree-species>). In the area of Romania, both species are found in mixed hardwood forests, mainly located in the Southern and Western Sub-Carpathians.

According to Richter and Dallwitz (2000), Turkey oak belongs to the red oaks group, having a reddish, less brown color, larger, thick-walled latewood vessels, and higher density, compared to the sessile oak, which belongs to the white oaks group, together with

the pedunculate oak. This may explain why Turkey oak wood behaves differently compared to sessile oak and pedunculate oak, as far as its drying and processing are concerned.

While the properties of sessile oak are well-known (Holzatlas 2008, Wood Database), and this species is widely used for the furniture production, Turkey oak wood has been severely neglected until now, and it is still mainly used as firewood. The same situation applies in Slovenia (Merela and Cufar 2013), Kosovo (Bajraktari 2018), and also in Albania (Stafasani and Toromani 2015). This is mainly due to its high tendency to crack (Ferrari *et al.* 2013), which makes drying very difficult, its lower dimensional stability and lower hardness (Giordano 1981), the difficult treatment (Uzielli 1989), and a deficient gluing capacity (Lavisici *et al.* 1991).

A broad description of the main features of Turkey oak wood is provided in the Wood Database ([https:// www.wooddatabase.com/turkey-oak/](https://www.wooddatabase.com/turkey-oak/)). In recent years, several more in-depth studies were conducted in Europe, which focused on the better understanding of this species. For example, Nunes (2017) studied the anatomical features of Turkey oak wood from two different regions from Kosovo. Among other features, she measured the pore diameters, and obtained values of 72 to 73 μm for the latewood pores, 274 to 279 μm for the earlywood pores, and 134 to 135 μm as an overall average, which is slightly lower than the values obtained by Carvalho (1997): 150 to 210 μm , for the same species. Microscopic images taken by means of confocal laser scanning microscope, and a description of the microscopic features of Turkey oak wood, were also published by Balzano *et al.* (2020).

Manetti (2002) determined the annual ring widths for 46 Turkey oak trees from 5 different locations from Central and Southern Italy and obtained values ranging within 2.2 to 2.9 mm during the first 15 years, while the up-following 10 years (up to the tree age of 25) were characterized by narrower rings (1.5 to 1.7mm). Slightly lower values, 1.21 to 1.76 mm were obtained by Nunes (2017). It must be specified that this feature is strongly influenced by the growing conditions, the climate, the soil, the distance between the trees, *etc.*

The annual ring width for different oak species (including sessile oak) and its correlation to density was also studied by Vavrcik and Gryc (2012).

As far as the chemical composition is concerned, Traoré *et al.* (2018) employed FTIR-ATR spectroscopy (alongside Pyrolysis - Gas Chromatography - Mass Spectrometry (py-GC-MS) as a chemometric tool for identification of archaeological wood (Iberian shipwrecks from 16th to 18th centuries) from different oak species (*Q. petraea*, *Q. robur*, *Q. faginea*, *Q. pyrenaica*). Extensive FTIR (and Py-GC-MS) databases resulted from analysis of more than 1,000 FTIR spectra recorded on the four different *Quercus* spp., on material from living oaks and archaeological Iberian shipwrecks were built. The relative intensities of the main absorbance bands in the fingerprint region (1800 to 600 cm^{-1}), assigned to the main wood components cellulose, hemicelluloses, and lignin were employed as the basis for further Principal Component Analysis (PCA) and Discriminant Analysis (DA). Spectra were recorded throughout the wood cores, at 1 cm intervals, in order to facilitate understanding the variability in wood chemical composition. Accordingly, the database provides FTIR chemical details related to differences between sapwood, transition wood and heartwood; between various *Quercus* wood species; between new sound wood and archaeological wood.

Imaging FTIR spectroscopy, respectively the variation of the relative intensities of relevant absorbance bands assignable to the main wood components was also employed by Ren *et al.* (2023) to compare chemical compositions of sapwood and heartwood of *Michelia macclurei*.

Data on the extractives content of Turkey oak are provided by Bajraktari *et al.* (2018), who applied the ethanol-water extraction method for Turkey oak heartwood and obtained a total content of extractable substances of 6.43 to 6.99%. This is a much lower amount than obtained by the same method, *e.g.* for pedunculate oak (*Quercus robur*) by Carmona (2009): 14.8 to 15.7%. These results classify Turkey oak heartwood as a wood grade with a very low amount of extractives, which was also confirmed by Lavisca *et al.* (1991).

Lo Monaco *et al.* (2011) studied the effect of moisture on the physical parameters of Turkey oak wood. Interesting correlations between the physical properties and the anatomical features of several oak species (*Quercus petraea*, *Q. robur* and *Q. rubra*) were obtained by Nepveu (1984).

With values above 720 kg/m³ (Richter and Dallwitz 2000; Merela and Cufar 2013; Pasztory *et al.* 2014; Nunes 2017; Bajraktari 2018), the oven-density of Turkey oak turns out to be higher than that of sessile oak wood, which is around 650 kg/m³ (Holzatlas 2008).

The shrinkage coefficients of Turkey oak wood maintain the same tendency, being higher than those of sessile oak wood. For example, the volumetric shrinkage coefficient of Turkey oak wood is 16.0 to 19.2% (Lo Monaco *et al.* 2017; Nunes 2017), compared to 12.6 to 15.6% (Holzatlas 2008; Glass and Zelinka 2010).

According to the Wood Database, the shrinkage anisotropy coefficient is higher for sessile oak wood, with an average of 2.16, compared to 1.7 for Turkey oak wood.

The main objective of the present research was to examine comparatively the most important anatomical, chemical, and physical features of the two species originating from the Romanian Southern Sub-Carpathians, in order to find correlations between these features, and thus to better understand the peculiarities of Turkey oak wood which influence the drying behavior of this species.

EXPERIMENTAL

The wooden samples used within the experiments were obtained from a sessile oak tree and a Turkey oak tree having similar age, both originating from the area of the Southern Sub-Carpathians (45°N 24°E) (Fig. 1), situated at an altitude of 410 m. According to the Köppen-Geiger classification (Beck *et al.* 2018), the plot location is characterized by a continental climate. The average annual temperature is 10.5 °C, the average annual rainfall amounts at 578.6 mm, and the average wind speed is usually lower than 1 m/s, with a maximum of 2.1 m/s.

The characteristics of the two trees are listed in Table 1.

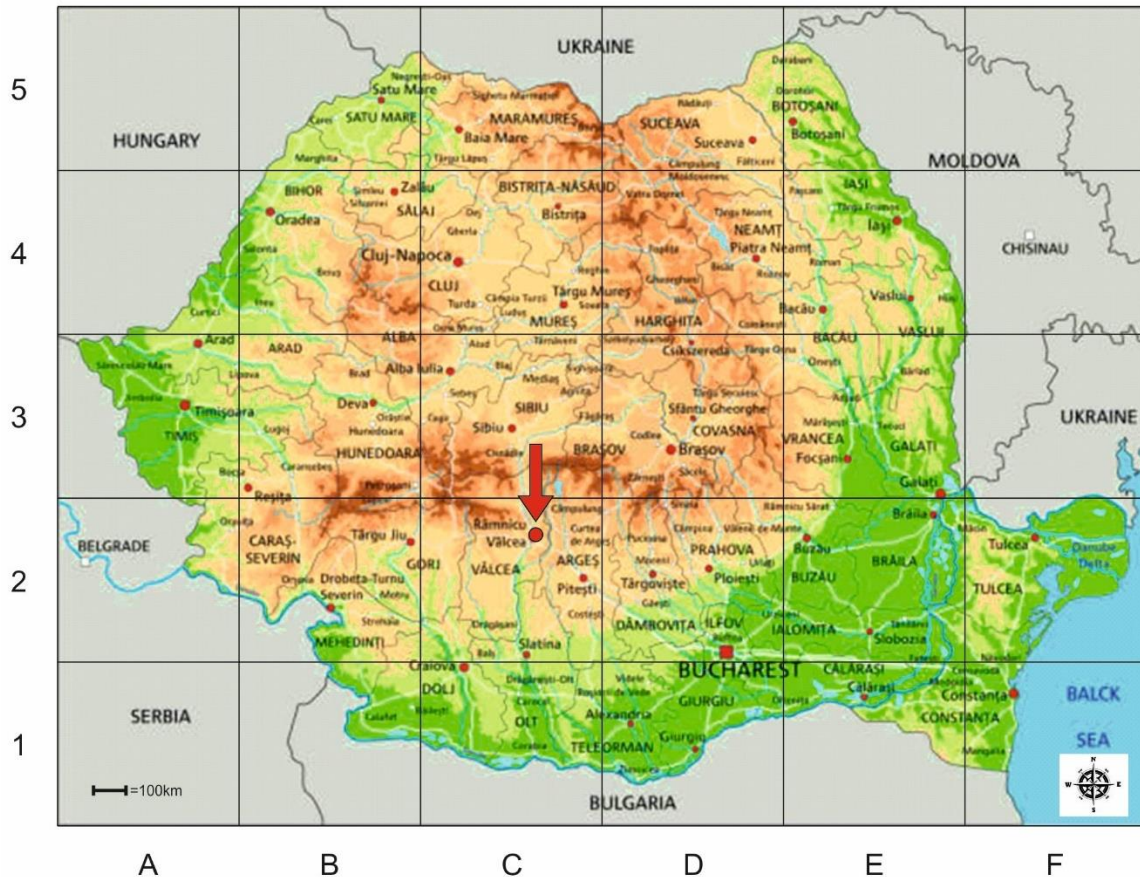

Fig. 1. Map of Romania: the red arrow in square C2 shows the position of the forest plot in the Southern SubCarpathians wherefrom the Turkey oak tree and the sessile oak tree used in these experiments was harvested

Table 1. Tree Characteristics

Characteristics	Turkey oak	Sessile oak
Age (years)	112	110
Diameter over bark at 1.3m (cm)	54.5	50.5
Total height (m)	22.4	25.0
Stem height below the crown (m)	10.7	11.3
Top diameter over bark (cm)	42.5	41.0
Average moisture content (%) (determined by the oven-drying method)	66.2	66.9

Three 10-cm thick disks were cross-cut from different heights of each stem, according to the prescriptions of ISO 4471 (1982). The bottom disks were cut at 1.3 m from the bottom of each stem. They were used to analyze comparatively the anatomical features of the two species. The mid-height disks were cut at 1/3 of the tree height. They were used for the determination of the chemical composition. The top-disks were cut 1 m below the crown. The physical properties were determined on samples taken from all three disks from each stem, to enhance not only the determination of the average values of the selected properties, but also their variation along the tree height.

Microscopic images were obtained by means of a NIKON SMZ18 stereomicroscope (Tokyo, Japan). Images 22.5x magnified allowed establishing the average pore diameters in earlywood, both in sapwood and heartwood.

The macroscopic features examined were:

- the characteristics of the annual rings (widths, average width, maximum width, regularity index of annual rings width; proportion of latewood/earlywood within the annual ring);
- the proportion of heartwood / sapwood;
- the color differences between the two zones (heartwood and sapwood).

The width of the annual rings was determined along the main diameter (longest diameter drawn through the anatomical center of the disk, as shown in Fig. 2), and then the average width (b_m), the regularity index (r) and the proportion of latewood (P_{LW}) were calculated by Eqs. 1, and 2:

$$b_m = \frac{\sum b}{n} \quad (\text{mm}) \quad (1)$$

$$P_{LW} = \frac{\sum b_{LW}}{\sum b} \cdot 100 \quad (\%) \quad (2)$$

where n is the number of annual rings along the main diameter (longest diameter through the geometric centre), $\sum b$ is the sum of all annual ring widths along the main diameter (mm), b_{max} is the maximum annual ring width (mm), and $\sum b_{LW}$ is the sum of the latewood zones from all annual rings along the main diameter (mm).



Turkey oak disk



Sessile oak disk

Fig. 2. Cross-cut disks used for the comparative determination of the anatomical features of Turkey oak and sessile oak wood

The proportion of heartwood (P_{HW}) was determined by calculating the ratio between the area of the heartwood zone, and the area of the whole cross section (without bark) (Eq. 3),

$$P_{HW}(\%) = \frac{d^2}{D^2} \times 100 \quad (3)$$

where d is the average diameter of the heartwood area (m), and D is the average diameter of the cross section of the disk (without bark) (m). Due to the ovality of the disks, both diameters were determined as arithmetic means of two perpendicular diameters drawn through the geometric center of the disk.

Another macroscopic feature, the color of the samples, was assessed in the CIELab system, by means of an AvaSpec-USB2 spectrometer (by Avantes Apeldoorn, Netherlands), equipped with an AVA sphere $\Phi 80$ mm for the measuring, and AVA Soft version 7.7 color application software for the data processing. Three samples of each species, having the dimensions of 180 x 20 x 18 mm, on the radial, tangential, and longitudinal directions, respectively, and a moisture content of 8%, were employed for the color measurements on the cross-section in several positions, at 20 mm intervals along the radius, from sapwood inwards (Fig. 3). The Turkey oak samples, which had a larger area of sapwood, allowed measurement in 2 points: circular areas of 8 mm diameter in the sapwood and in 5 points in the heartwood area. The sessile oak samples allowed measurement in only one point in sapwood and in 6 points in the heartwood area.



Fig. 3. Color measurement by means of an AvaSpec-USB2 spectrometer (by Avantes Apeldoorn, Netherlands)

The three-color coordinates (L^* -lightness, a^* - redness, and b^* -yellowness) were determined for each point, and then their average was calculated for each wood type. The lightness (L^*) is an important qualitative indicator capable of eliminating the subjective perception by the naked eye (especially when the nuances are quite similar): the lower its value is, the darker wood is. On the other hand, the chromatic coordinates a^* and b^* are helpful in distinguishing the different color shades. In order to determine the color difference (ΔE) between sapwood and heartwood for each species, Eq. (4) was applied:

$$\Delta E = \sqrt{(\Delta L)^2 + (\Delta a)^2 + (\Delta b)^2} \quad (4)$$

In order to rapidly evaluate and compare the main chemical structural characteristics of the two wood species under investigation, as well as those differentiating heartwood and sapwood of each wood species, Fourier Transformed Infrared spectroscopy (FTIR) was employed in this research. Investigation was carried out with an Alpha-Bruker FTIR spectrometer (Ettlingen, Germany) equipped with ATR (Attenuated Total Reflectance)

module. The spectra were recorded in the range 4000 to 600 cm^{-1} , at a resolution of 4 cm^{-1} and 24 scans, on un-extracted sawdust samples. Spectra were recorded on 3 replicates for each wood type. The recorded spectra were further processed for baseline correction and smoothing, and average spectra were computed for each category of sample using the OPUS software (version 7.2, Bruker, Ettlingen, Germany). Average spectra were further normalized (Min-Max normalization) and compared to highlight common and differentiating chemical features. For this purpose the absorbance bands (peaks) and their relative intensities were extracted from the OPUS recorded and processed data and compared.

Not only the main chemical composition, but also the secondary compounds, especially the extractives, are important when characterizing a wood species. Extractives represent a mixture of low- and high-molecular weight compounds that can be extracted from wood with cold/hot water and organic solvents. According to their chemical structure, extractives can be divided into three main classes: aliphatic compounds, terpenes, and phenols (polyphenols). The first two main classes of extractives are lipohylic compounds, which may be extracted in non-polar or low polarity solvents (*e.g.* cyclohexane, hexane, acetone, mixtures cyclohexane-ethanol, benzene-ethanol), while the phenolic compounds, which include the various types of tannins, are hydrophylic and can be extracted in polar solvents (*e.g.* water, ethanol, mixtures ethanol-water) (Lehr *et al.* 2021). In alkaline solutions (*e.g.* NaOH 1%) the solubility of phenolic compounds will be increased, so that polyphenols were the main components of radiata pine bark extracts in NaOH 1% solution (Lee *et al.* 2020). Also, alkaline solutions of pH 9 to 10, are capable of dissolving even at room temperature non-structural wood compounds, such as: dyes, simple sugars, resin and fatty acids. Furthermore, pentosans undergo degradation in alkaline environment and can be dissolved in alkaline conditions (Doczekalska and Zborowska 2010, citing Prosiński 1984).

The extractives affect the properties and also the drying behavior of wood. Therefore, the extractives content of Turkey oak and sessile oak sapwood and heartwood was also determined within the present research. Cold water, hot water, and NaOH extraction were used for this purpose.

For these tests, sawdust samples were taken from the sapwood and heartwood of the two species. Their moisture content was determined by the oven-dry method. Then the sawdust probes were screened, and the fraction which passed through the 0.5 mm sieve meshes, but did not pass through the 0.25 mm ones, was used within the tests. Four replicates, weighing $2 \pm 0,0001$ g each, were used for each type of wood in each test.

After each extraction (cold water / hot water / NaOH 1%), the contents of soluble substances were calculated based on the measured masses and moistures, according to Eq. (5),

$$\% \text{Extractable substances} = \frac{m_1 \cdot (100 - MC) - 100 \cdot m_2}{m_1 \cdot (100 - MC)} \cdot 100 \quad (5)$$

where m_1 is the sawdust mass before the extraction (g), m_2 is the sawdust mass after the extraction (g), and MC is the moisture content of the sawdust sample (%).

To determine the physical properties, all six disks were cut into 20 mm thick baguettes (Fig. 4) containing both heartwood and sapwood. From these, cubic-shaped samples (20 x 20 x 20 mm), containing either only heartwood (HW) or only sapwood (SW) were obtained. These were used to determine the selected physical properties: oven-dry density, total shrinkage coefficients, shrinkage anisotropy coefficient, and fiber saturation moisture content.

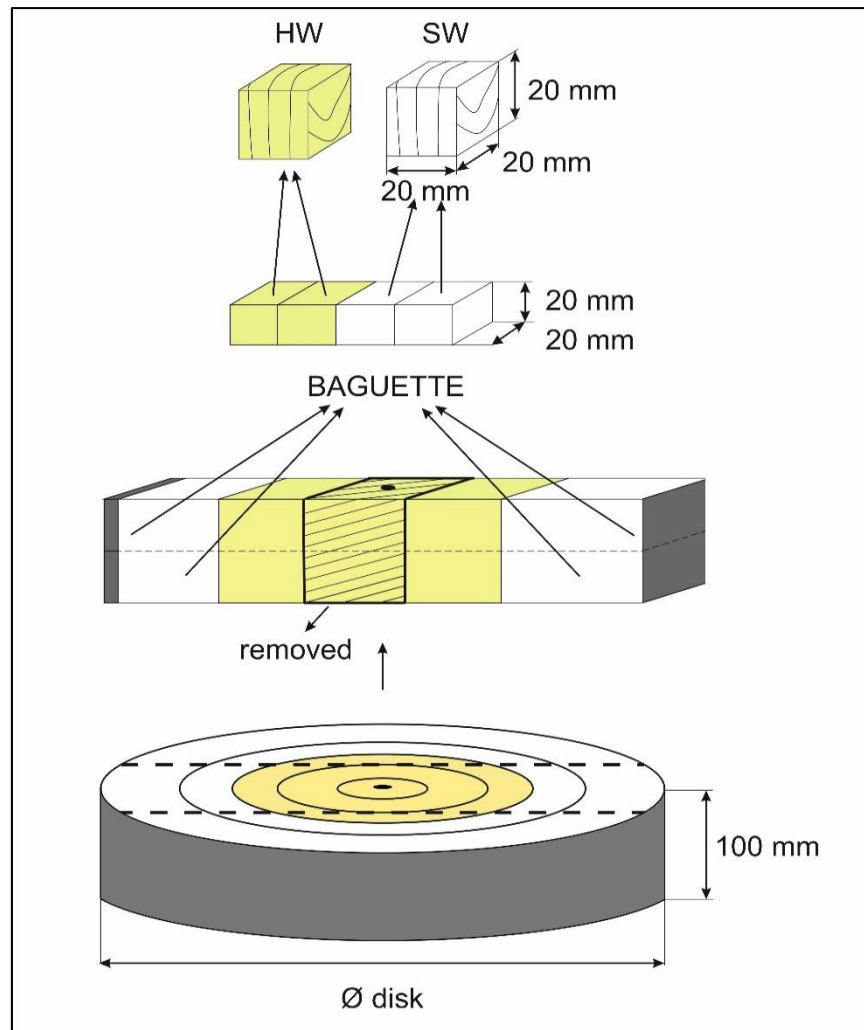

Fig. 4. Preparation of heartwood and sapwood samples for the determination of the selected physical properties

A total number of 102 samples (83 from heartwood, and 19 from sapwood) were obtained from the Turkey oak tree, and 134 samples (118 from heartwood, and 16 from sapwood) were obtained from the sessile oak tree.

All samples were numbered, then weighed with 0.01g precision and measured with 0.01 mm precision, in the green state. Then they were oven-dried at 103 °C, cooled for 30 min in a desiccator, and then weighed and measured again in oven-dry state.

The oven-dry density (ρ_0), the basic density (ρ_c), the total radial, tangential, and volumetric shrinkage coefficients (β_r , β_t , β_v) were determined according to the accepted standards (ISO 4469 1981; ISO 7858 1982; ISO 13061-2 2014), as function of the measured masses and dimensions (Eqs. 6 through 9). Afterwards, the shrinkage anisotropy (β_t/β_r) was calculated, and also the fiber saturation point (*FSP*), according to Eq. 10 (Filipovici 1965),

$$\rho_0 = \frac{m_0}{v_0} (\text{kg/m}^3) \quad (6)$$

$$\rho_c = \frac{m_0}{V_{max}} \text{ (kg/m}^3\text{)} \quad (7)$$

$$\beta_{r,t} = \frac{r_{max}(t_{max}) - r_0(t_0)}{r_{max}(t_{max})} \cdot 100 \text{ (\%)} \quad (8)$$

$$\beta_v = \frac{V_{max} - V_0}{V_0} \cdot 100 \text{ (\%)} \quad (9)$$

$$FSP = \left(\frac{1000}{\rho_c} - \frac{1000}{\rho_0} \right) \cdot 100 \text{ (\%)} \quad (10)$$

where m_0 is the oven-dry mass (kg), V_0 is the oven-dry volume (m^3), V_{max} is the maximum volume (at fiber saturation point or above) (m^3), r_{max} and t_{max} are the maximum dimensions in radial and tangential direction (at fiber saturation point or above), respectively (mm), and r_0 and t_0 are the oven-dry dimensions in radial and tangential direction, respectively (mm).

All experimentally obtained values were statistically analyzed to establish if there was a significant difference between the two species, and also, between the sapwood and heartwood samples, respectively.

The statistical analysis was performed with the Data Analysis ToolPack in Microsoft Excel. One Way Analysis of Variance (Pallant 2007) was run to figure out if there was a significant difference among the analyzed groups, on a single independent variable (the wood type). This statistical test was also used to compare the means of samples made of heartwood and sapwood. During the One-Way ANOVA analysis, the significance level (α) was equal to 0.05, which is considered to provide a low risk of error, namely 5% (Gravetter and Wallnau 2011). In addition, the t-test for two independent groups was applied as Post Hoc test together with Bonferroni correction to reveal which pairs of mean differences are statistically significant (Oleksik and Rořca 2023). The Bonferroni correction implies dividing the adopted significant alpha level, namely 5% in this study, at the number of analyzed groups. When analyzing the variation of the properties over the tree height (see Table 10), the number of analyzed groups was three. Therefore, in this case the significant alpha level was equal to 0.00167 during the Post Hoc analysis.

RESULTS AND DISCUSSION

Anatomical Features

The microscopic images (Fig. 5) revealed some similarities, but also some differences regarding the anatomical features of the two species. Both species are ring-porous, with distinctive earlywood (EW) and latewood (LW) zones. At the microscopic level, the distinction is given by the much higher diameter of the earlywood pores, both in the sapwood, and in the heartwood of the two species (Table 2). In sapwood, the pores are completely empty in both species, but in heartwood, they are partially filled with tyloses (see Fig. 5). Both species display rays of two distinctive sizes (wide - well visible by the naked eye, and narrow - hardly visible by the magnifying glass).

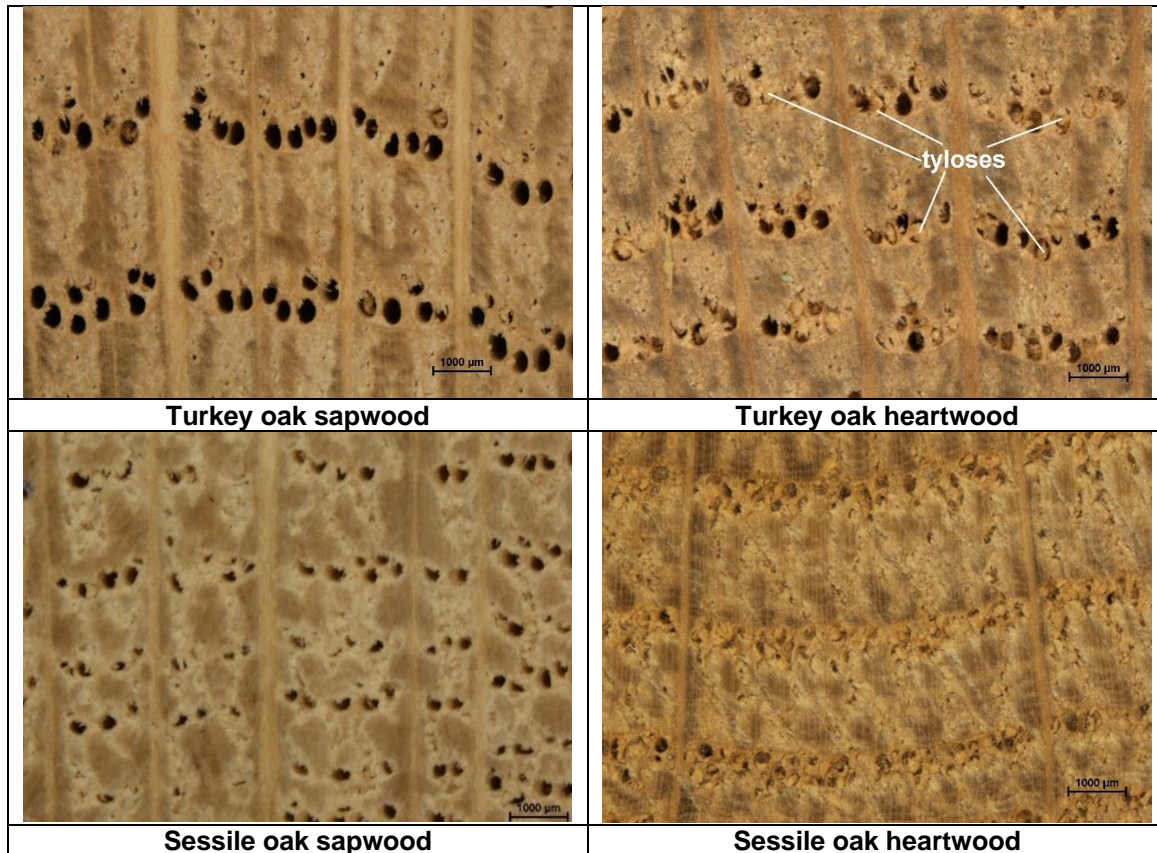

Fig. 5. Cross section (magnified 22.5x) of Turkey oak and sessile oak sapwood and heartwood

Table 2. Diameter of Earlywood Pores in Turkey Oak and Sessile Oak Sapwood and Heartwood (min-mean-max values, and standard deviation)

Turkey oak SW	Turkey oak HW	Sessile oak SW	Sessile oak HW
194.98-308.31-398.74 (64.81)	184.81-294.94-393.1 (55.72)	165.56-273.12-379.34 (80.19)	193.47-250.75-305.91 (27.03)

Characteristics of Annual Rings

As far as the characteristics of the annual rings are concerned, Fig. 6 presents their variation in radial direction. The Turkey oak tree displays wider rings in the central part (within the first 15 years, $b = 1 \dots 3$ mm, and the average $b_m = 1.98$ mm). During the next 10 years the annual ring width starts decreasing ($b_m = 1.44$ mm), and the heartwood zone between ring 25 and ring 74 is characterized by very narrow ring widths ($b_m = 0.43$ mm). In the sapwood zone, the widths increase again ($b_m = 2.44$ mm). In this area, the widest ring ($b_{max} = 4.5$ mm) is found. The values fit in the intervals reported by other researchers (Nunes 2017; Manetti 2002).

Unlike this, in case of the sessile oak, the annual rings are clearly wider in the central area of the cross-section (within the first 15 years, $b = 1.5 \dots 6.5$ mm, and the average annual ring width is $b_m = 3.64$ mm). After 40 years, the ring widths decrease to $b_m = 0.2$ mm, and maintain this value towards the periphery of the heartwood zone. In the sapwood, the ring width increases slightly, to $b_m = 1$ mm.

With both species, the width of the latewood zone increases with the width of the annual rings. Accordingly, the proportion of latewood is also slightly higher in sessile oak wood: $P_{LW} = 58.17\%$, compared to Turkey oak wood: $P_{LW} = 56.36\%$.

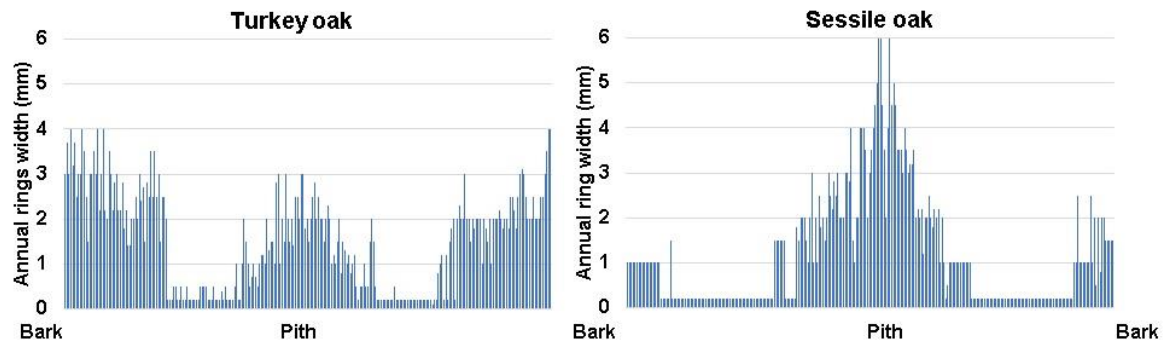

Fig. 6. Variation of annual ring width along the main diameter of the cross-section of a Turkey oak tree, and of a sessile oak tree of the same age

Proportion of Heartwood

By examining the cross-cut disks (see Fig. 2), it can be easily observed that the proportion of heartwood is much lower in Turkey oak than in sessile oak wood. The calculations based on Eq.(3) confirmed the visual impression: $P_{HW} = 50.64\%$ for Turkey oak wood, and $P_{HW} = 91.56\%$ for sessile oak wood. A similar result ($P_{HW} = 43-53\%$) was obtained by Bajraktari (2018) for Turkey oak. This means that only narrow lumber pieces can be obtained from a Turkey oak stem, so as to contain either only sapwood, or only heartwood, while normally wide pieces will comprise both areas (Fig. 7). These lumber pieces are highly appreciated for rustic furniture, but their drying is challenging due to the inner stresses generated in the transition area. Therefore, the separate density determination of the two areas is important with a view to elaborating an appropriate drying schedule.



Fig. 7. Turkey oak lumber containing both sapwood and heartwood

Color

Table 3 presents the results concerning the color of the four types of wood. According to the value of the lightness (L^*) coordinate, it can be noticed that Turkey oak sapwood is slightly darker ($L=73.67\pm 0.90$) than sessile oak sapwood ($L=76.5\pm 3.15$), while Turkey oak heartwood ($L=61.55\pm 0.99$) is lighter than sessile oak heartwood

($L=60.35\pm 2.80$). Hence, the calculated color difference (ΔE) between the sapwood and the heartwood is more distinctive for the sessile oak wood (16.55) compared to Turkish oak wood (12.33). The two wood species differ also in terms of chromaticity. The redness values a^* for Turkey oak, for both sapwood and heartwood, are higher with 0.4 to 1.0 units than the corresponding values for sessile oak. Contrarily, the yellowness values b^* for sessile oak, for both sapwood and heartwood, are higher, with 0.71 to 2.65 units, than those measured for Turkish oak. To conclude, color measurements in the CIELab system indicate a reddish shade for Turkish oak and a less pronounced contrast between sapwood and heartwood, while a yellowish shade and a higher contrast between sapwood and heartwood is characteristic to sessile oak. These color data and conclusions are in good accordance to the visual perception (see Fig. 2).

Table 3. Average Values (and Standard Deviations) of the Color Coordinates of Turkey Oak and Sessile Oak Sapwood and Heartwood

Wood samples	Turkey oak				Sessile oak			
	L^*	a^*	b^*	ΔE	L^*	a^*	b^*	ΔE
SW	73.67 (0.90)	4.05 (0.16)	15.77 (1.26)	12.33	76.5 (3.15)	3.05 (0.58)	16.48 (1.32)	16.55
HW	61.55 (0.99)	6.34 (0.28)	16.07 (0.31)		60.35 (2.80)	5.94 (0.75)	18.72 (1.52)	

The comparative normalized average spectra presented in Fig. 8 (range 2000 to 600 cm^{-1} , encompassing the fingerprint region), as well as the data in Table 4, illustrate the common chemical characteristics of the four types of wood samples, as well as some differentiating features, related to the polymeric matrix formed by the three main chemical components: cellulose (Cel), hemicelluloses (H Cel) and lignin (L). The assignment of the main absorbance bands was based on literature references (e.g. Faix 1991; Pandey and Pitman 2003; Gierlinger *et al.* 2004; Popescu *et al.* 2006, 2007; Gierlinger *et al.* 2008; Popescu *et al.* 2009; Tamburini *et al.* 2017).

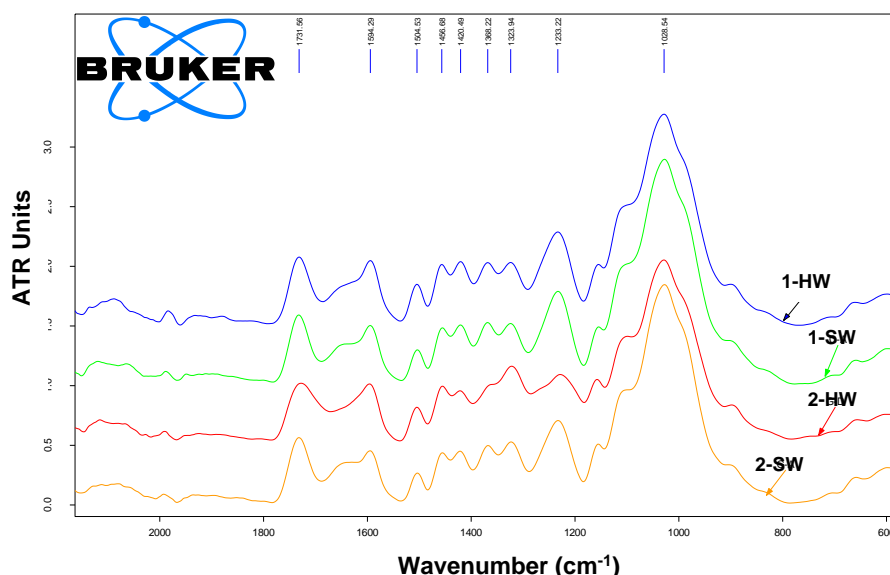

Fig. 8. Comparative FTIR spectra for: 1 - Turkey oak (HW –blue and SW- green) and 2 – Sessile oak (HW – red and SW - orange) in the range 2000-600 cm^{-1} , encompassing the fingerprint region)

A first examination of the spectra indicates a similar qualitative chemical composition (similar absorbance peaks) for all four wood types. However, there are some small differences in the relative intensity of several peaks, which suggests some quantitative differences based on the proportion/ratio between certain compounds.

The absorbance band at 1728 to 1732 cm^{-1} assignable to the stretching of unconjugated carbonyl groups C=O, is associated in the case of wood mostly to the CO stretching mode of acetyl or carboxylic acid groups present in HCel (*e.g.* xylan, xyloglucan, uronic acids). The main lignin associated absorbance bands are those at 1594 to 1595 cm^{-1} (aromatic ring vibration plus C=O), 1504 to 1505 cm^{-1} (aromatic skeletal vibration), 1323 cm^{-1} (C-O vibration in syringyl and syringyl ring breathing), with a contribution of C-H vibration in cellulose (Cel) and 1233 cm^{-1} (syringyl ring plus C-O stretch in lignin), with a contribution of C-C, C-O and C=O stretch of acetyl groups in xylans. The absorbance at 1456 cm^{-1} was assigned to C-H deformation in lignin and carbohydrates, aromatic vibration of lignin and asymmetric C-H bending in methoxyl groups of lignin. The absorbance at 1421 cm^{-1} (C-H bending and deformation) reflects also a combined contribution of lignin and carbohydrates. The main absorbance bands specific to the carbohydrates are those at 1368 cm^{-1} (C-H symmetric deformation in Cel, HCel), 1155 cm^{-1} (C-O-C symmetric stretch in Cel and HCel), 1028 cm^{-1} (C-O, C-O-C deformation – Cel and HCel) and 898 cm^{-1} (C-H deformation in Cel). The absorbances at 1368 cm^{-1} , 1155 cm^{-1} and 898 cm^{-1} appear only as small peaks, the latter two ones being encompassed as shoulders, slightly more distinct for sessile oak than for Turkish oak, in the large absorbance band at 1028 cm^{-1} .

A visible differentiating feature is the small absorbance at 1644 to 1647 cm^{-1} , assigned to conjugated carbonyl groups, such as aromatic ketones, p-substituted conjugated aryl ketones and quinones. These are (sub)structures that might be present in the structure of lignin and in some extractives (Fengel and Wegener 1984), though the contribution of extractives is not usually detectable by FTIR due to their low content (Tolvaj *et al.* 2013), usually below 5-10% (Fengel and Wegener 1984). This absorbance is present as a shoulder at 1647 cm^{-1} in the spectra of Turkey oak, slightly more distinctive for SW compared to HW, whilst in the case of sessile oak a small absorbance at 1644 cm^{-1} is present only in the spectrum of SW. Also, for the sessile oak the absorbance at 1368 cm^{-1} (C-H in Cel, HCel) appears as a clearly differentiated peak for sapwood, being reduced to only a shoulder for the heartwood. At the same time the absorbance at 1323 cm^{-1} (L with a contribution of Cel) appears as the highest for sessile oak HW from all four types of material, whilst that at 1233 cm^{-1} appears as the smallest for the same material. A higher relative intensity of the absorbance band at 1323 cm^{-1} compared to that at 1732 to 1738 cm^{-1} appears as a feature of sessile oak sapwood compared to heartwood, according to the FTIR database created by Traoré *et al.* (2018).

The above discussed differences, as well as other semi-quantitative differentiating aspects between the two species and the heartwood and sapwood of each species are reflected in the data in Table 4, where the relative intensities of the main absorbance bands in the region 1800 to 800 cm^{-1} , alongside their assignment in relation to the wood main chemical components, are listed and the ratios between HW and SW were computed. Ratios of 1(\pm 0.1) would indicate quite similar chemical composition for the sapwood and heartwood of the respective wood species, while higher or lower values would suggest some differences, higher for ratios more different than 1.

Table 4. Comparative FTIR Data: Absorbance Bands and Relative Intensities of Selected Absorbance Bands in the Region 1800-800 cm^{-1} , for the Four Types of Wood: Turkey Oak (HW, SW) and Sessile Oak (HW, SW)

Absorbance wavenumber [cm^{-1}]	Wood chemical component	Turkey oak			Sessile oak		
		HW	SW	HW/SW	HW	SW	HW/SW
1732 - 1738	HCel	0.552	0.560	0.99	0.478	0.542	0.88
1594 - 1596	L	0.444	0.399	1.11	0.371	0.357	1.04
1504 - 1505	L	0.232	0.196	1.18	0.195	0.177	1.10
1455 - 1457	L. (Cel+HCel)	0.154	0.132	1.17	0.276	0.117	2.36
1420 - 1422	L. (Cel+HCel)	0.373	0.229	1.63	0.067	0.204	0.33
1368	Cel + HCel	0.129	0.327	0.39	shoulder	0.119	-
1322 - 1324	L. (Cel)	0.211	0.155	1.36	0.431	0.283	1.52
1229 - 1233	L. (HCel)	0.593	0.633	0.94	0.202	0.527	0.38
1028 - 1029	Cel. HCel	1.796	1.879	0.96	1.511	1.830	0.83
898	Cel	shoulder	shoulder	-	shoulder	shoulder	-

According to the data in Table 4, the most obvious differences in the spectra of HW and SW of Turkey oak are those reflected by the absorbances related to lignin at around 1504, 1456, 1420 and 1323 cm^{-1} , for which the calculated ratios HW/SW were 1.18, 1.17, 1.63 and 1.36, respectively, all suggesting a higher lignification of heartwood compared to sapwood. At the same time, the ratio of 0.39 calculated for the absorbance at 1368 cm^{-1} (Cel + HCel) for HW/SW suggests a lower content of holocellulose in the heartwood compared to sapwood, while the ratio of 0.99 HW/SW calculated for the absorbance at 1368 cm^{-1} (HCel) suggests similar content of hemicelluloses in HW and SW. This hints towards a lower content of cellulose in the more lignified heartwood of Turkey oak compared to sapwood.

By comparison, in the case of sessile oak, the ratio HW/SW for the most characteristic absorbance of lignin at 1504 cm^{-1} was 1.10 (possibly slight increased L content in HW), while the ratios HW/SW most different from $1(\pm 0.1)$ were those calculated for the composite absorbances (lignin with a contribution of carbohydrates) at 1456 cm^{-1} (2.36), 1323 cm^{-1} (1.52) as the highest values, and at 1233 cm^{-1} (0.38) at the lowest value. This wavy evolution of these ratios is difficult to explain without a correlation with complementary analytical methods and should not be seen only as a quantitative difference, but also as an indication of possible differences in the complex structure of the syringyl-guaiacyl lignin (SGL) specific to the hardwoods. For instance, the higher relative intensity of the absorbances at 1456 cm^{-1} for HW of sessile oak (0.276 compared to 0.117 for SW and values of 0.154 and 0.132 for Turkey oak HW and SW) may indicate more methoxyl groups, respectively a higher proportion of syringyl units in the structure of SGL lignin for sessile oak compared to Turkey oak. As far as carbohydrates are concerned, the absorbance bands associated to holocellulose (Cel+HCel) suggest for sessile oak a slightly lower content of hemicelluloses and cellulose in the HW compared to the SW.

Extractives Content

According to the values obtained within this research, Turkey oak heartwood contains the poorest amount of chemical components extractable in water and NaOH 1% solution, while sessile oak heartwood is the richest among the four varieties analyzed. The

most surprising result was obtained for the Turkey oak sapwood, which consistently displayed higher average values of extractives than the heartwood of the same species, regardless the extraction method. These differences were found statistically significant only for cold water and hot water.

Significant differences were obtained between the extractives content from the heartwood and the sapwood of sessile oak, where the heartwood contains 53 to 96% higher amounts of extractable substances than the sapwood.

Also, there were found higher amounts of extractives in the heartwood of sessile oak, compared to Turkish oak, with statistically different differences between them. In contrast, the amounts of cold and hot water extractives from the sapwood of the two species were quite similar, slightly higher for Turkish oak than sessile oak (5.34% vs. 4.55%, respectively 7.77% vs. 7.35%), with no statistically significant differences. The differences between the sapwood of the two species were found significant only for the substances soluble in NaOH 1% solution (21.6% vs. 17.53%).

Table 5. ANOVA Results Regarding the Comparison (Mean Values and Standard Deviations) Between the Extractives Contents from Turkey Oak and Sessile Oak Sapwood (SW) and Heartwood (HW)

Wood type	Contents of extractable substances (%)		
	Cold water extraction	Hot water extraction	NaOH extraction
Turkey oak SW	5.34 (0.63) A	7.77 (1.39) A	21.60 (1.38) A
Turkey oak HW	2.95 (0.64) B D	4.25 (0.98) B	17.07(2.02) A D
Sessile oak SW	4.55 (0.093) A D	7.35 (0.02) A C	17.53 (1.29) B D
Sessile oak HW	8.95 (0.047) C	11.26 (0.32) A D	26.94 (0.07) C

* The means, in each column, that do not share the same letter are significantly different one from another at the 0.0125% significance level.

Unfortunately, the available literature data are very scarce and difficult to compare as either only data on heartwood are presented, or the type of material is not specified, or it is a mixture of sapwood and heartwood sawdust. For instance, values of 5.1% for cold water extractives and 8.8% hot water extractives are presented for sessile oak in Holzatlas (2008), while values of 7.03% for hot water extractives from Turkey oak (mixture of 50%SW+50% HW) were reported by Stafasani *et al.* (2018).

Physical Properties

The average values obtained for the selected physical properties are synthesized in Table 6. The overall values were calculated considering the sapwood/heartwood proportion obtained for each species. A detailed interpretation including the statistical analysis of the experimental data is given hereinafter for the most relevant properties.

Table 6. Physical Properties of Turkey Oak and Sessile Oak Wood Originating from the Southern Sub-Carpathians (Mean Value and Standard Deviation)

Property	Turkey oak			Sessile oak		
	SW	HW	Overall	SW	HW	Overall
Oven-dry density ρ_0 (kg/m ³)	732.99 (34.45)	723.75 (51.25)	728.44	652.49 (24.63)	667.87 (46.24)	666.56
Basic density ρ_c (kg/m ³)	624.37 (29.71)	619.02 (38.24)	621.66	562.40 (20.01)	563.31 (30.71)	563.19

Radial shrinkage β_r (%)	5.08 (0.86)	4.84 (0.65)	4.96	4.51 (0.75)	5.26 (0.69)	5.24
Tangential shrinkage β_t (%)	9.54 (0.68)	9.37 (1.25)	9.45	9.19 (0.70)	10.26 (1.36)	10.16
Volumetric shrinkage β_v (%)	14.81 (1.10)	14.40 (1.58)	14.60	13.79 (1.47)	15.56 (1.69)	15.54
Shrinkage anisotropy β_t/β_r	1.936 (0.39)	1.960 (0.31)	1.948	2.083 (0.32)	1.967 (0.28)	1.997
Fiber saturation point (%)	23.79 (2.27)	23.30 (2.44)	23.54	24.55 (2.16)	27.59 (2.28)	27.57

Oven-dry Density

The statistical values obtained for the oven-dry densities of the four types of wood are presented in Fig. 9, and in Tables 7 to 9.

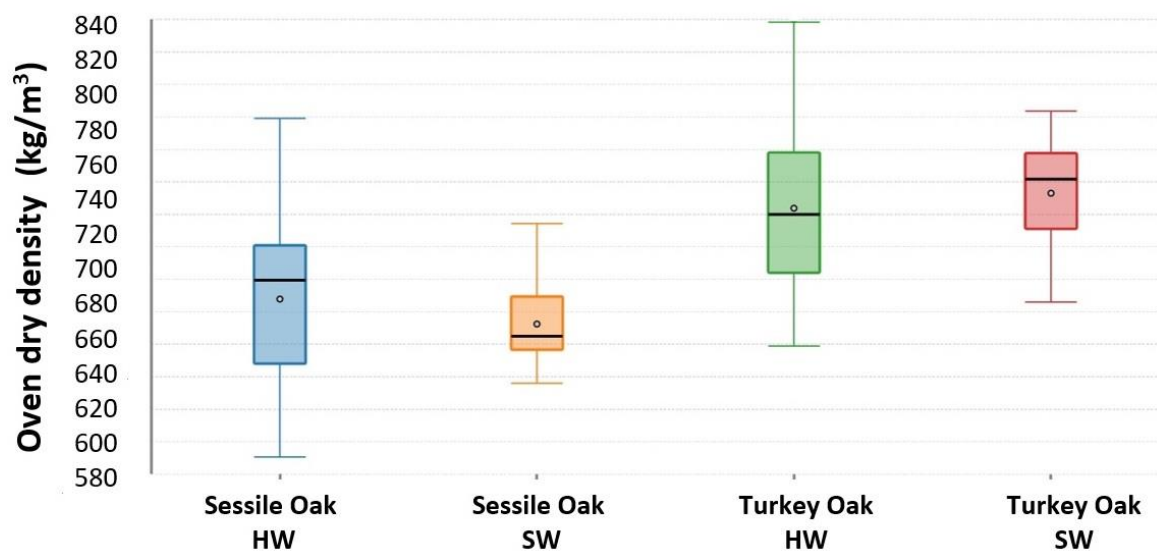

Fig. 9. Oven-dry densities of Turkey oak and sessile oak sapwood and heartwood

When comparing the mean values, sessile oak sapwood has the lowest (652 kg/m^3), while, surprisingly, Turkey oak sapwood has the highest value (733 kg/m^3). Although it is unusual for a ring-porous wood species to have higher density in the sapwood than in the heartwood, a similar result was obtained by Merela and Cufar (2013) for the same species. ANOVA revealed that the difference between the oven-dry densities of Turkey oak sapwood and heartwood is not statistically significant ($p\text{-value} > 0.05$) (see Table 7). This result can be attributed to the higher width of the annual rings in the sapwood of Turkey oak wood (see Fig. 6), which brings along a higher proportion of latewood, while the large number of very narrow annual rings in heartwood contributed to the density reduction of this wood area.

According to the statistical analysis (Tables 8 and 9), there is a significant difference ($p\text{-value} < 0.05$) between the oven-dry densities of the two species, both in the sapwood and in the heartwood.

Table 7. ANOVA Results Regarding the Comparison Between the Oven-Dry Densities of Turkey Oak Sapwood and Heartwood

Groups	Count	Sum	Average	Variance	SD	
Turkey oak HW	79	57176.7	723.76	2627.40	51.26	
Turkey oak SW	19	13926.9	732.99	1187.00	34.45	
Source of Variation	SS	df	MS	F	P-value	F crit
Between Groups	1307.08	1	1307.08	0.55	0.458	3.94
Within Groups	226303.58	96	2357.33			
Total	227610.66	97				

Table 8. ANOVA Results Regarding the Comparison Between the Oven-Dry Densities of Turkey Oak and Sessile Oak Sapwood

Groups	Count	Sum	Average	Variance	SD	
Turkey oak SW	19	13926.89	732.994	1187.00	34.45	
Sessile oak SW	16	10439.97	652.498	607.03	24.64	
Source of Variation	SS	df	MS	F	P-value	F crit
Between Groups	56280.42	1	56280.42	60.95	5.36E-09	4.14
Within Groups	30471.52	33	923.38			
Total	86751.94	34				

Table 9. ANOVA Results Regarding the Comparison between the Oven-Dry Densities of Turkey Oak and Sessile Oak Heartwood

Groups	Count	Sum	Average	Variance	SD	
Turkey oak HW	79	57176.75	723.756	2627.40	51.26	
Sessile oak HW	118	78809.51	667.877	2138.94	46.25	
Source of Variation	SS	df	MS	F	P-value	F crit
Between Groups	147754.46	1	147754.50	63.30	1.4E-13	3.88
Within Groups	455194.09	195	2334.33			
Total	602948.55	196				

As it can be noticed from Figs. 10 and 11, the variation of the oven-dry density over the cross section of the tree (along the main diameter) follows the pattern of the annual ring widths (see Fig. 6), for both species. Thus, as is clearly visible in the case of Turkey oak (due to the wide sapwood area), but also visible for the sessile oak, the density is higher in the central region, and at the periphery. This is a rather unusual radial distribution compared to the generally accepted pattern for ring-porous hardwoods, with a decreasing density from pith to bark, but it is clearly correlated with the annual ring widths variation. Thus, for both species, the central and the peripheric regions, where the wider annual rings are, have higher density as well. This must be correlated with the proportion of latewood with increasing annual ring width. Some sources from reference literature (*e.g.* Zeidler and Boruvka 2016; Longuetaud *et al.* 2017; Woodcock and Shier 2002), also report an inconsistent variation trend of density in radial direction for different oak species. Besides the growing conditions,

the proportion of juvenile and mature wood also influences the radial, and also the longitudinal variation of the physical properties (Rocha *et al.* 2019).

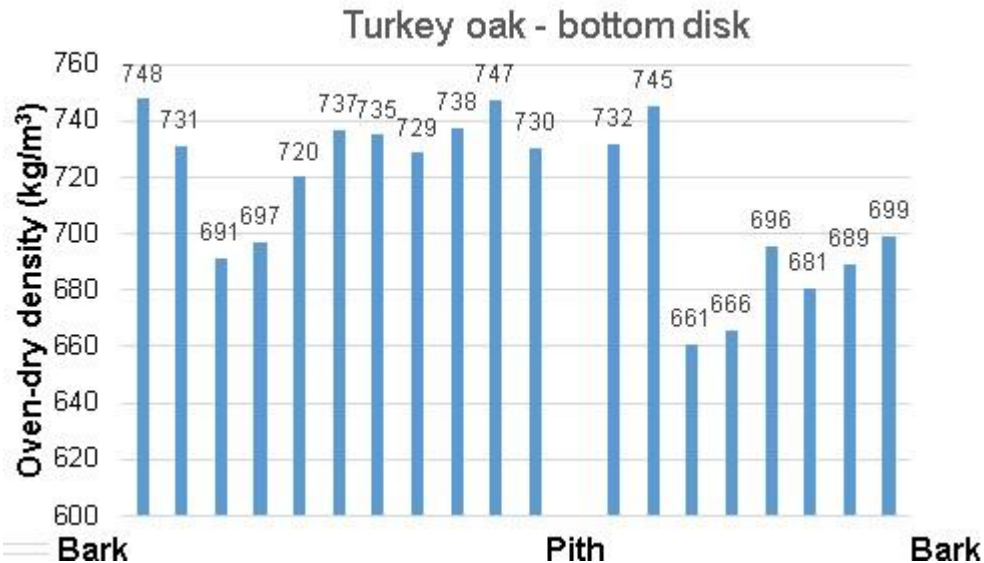

Fig. 10. Variation of the oven-dry density over the cross section of the Turkey oak tree

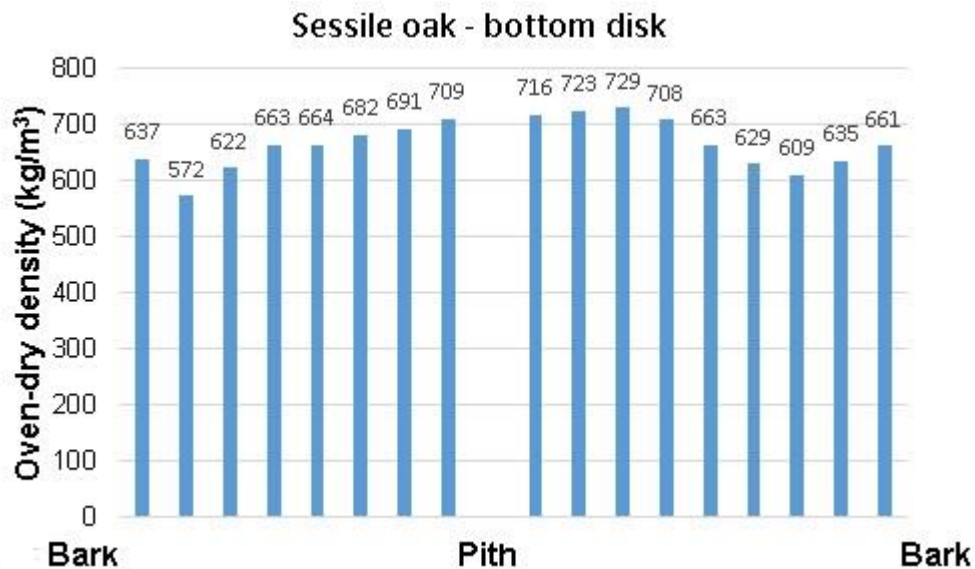

Fig. 11. Variation of the oven-dry density over the cross section of the sessile oak tree

As far as the variation of the oven-dry density over the tree height is concerned, for both species, and both for sapwood, and heartwood, the highest values were found at the top (at 1m below the crown), and the lowest values at 1/3 of the tree height (Fig. 12). A similar result was obtained by Pasztory *et al.* (2014). The ANOVA test (Table 10) revealed that there is a significant difference between the oven-dry density of wood from the bottom and the top of Turkey oak, both in the sapwood, and in the heartwood. Unlike this, in sessile wood the differences are not statistically significant (same as reported by Longuetaud *et al.* 2017).

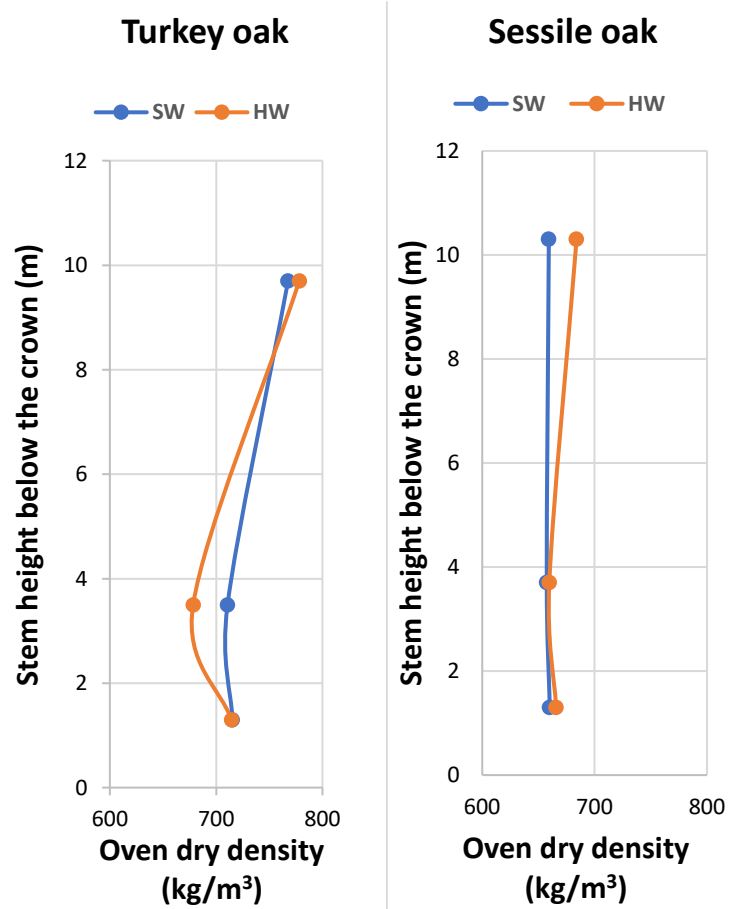

Fig. 12. Variation of the oven-dry density over the tree height

Table 10. ANOVA Results Regarding the Comparison Between the Variation of the Oven-Dry Densities of Turkey Oak and Sessile Oak Wood Along the Tree Height

Sample position along tree height	Turkey oak		Sessile oak	
	SW	HW	SW	HW
Bottom	715.27 (9) (26.96) A	714.48 (34) (31.84) A	660.25 (6) (12.97) A	665.88 (45) (46.22) A
Middle	710.58 (4) (39.46) AC	678.42 (24) (20.45) B	657.51 (6) (18.78) A	659.81 (45) (48.16) A
Top	767.69 (6) (12.42) BC	778.39 (25) (40.50) C	659.34 (4) (41.57) A	684.04 (28) (40.27) A

* The first value in each box represents the mean; the value in the first parentheses represents the number of replicates; the value in the second parentheses represents the standard deviation. The means in each column not followed by a common letter are significantly different one from another at the 5% significance level. Values with the same letter are not significantly different.

Shrinkage

The statistical values obtained for the volumetric shrinkage of the four types of wood are presented in Fig. 13, and in Tables 11 to 13.

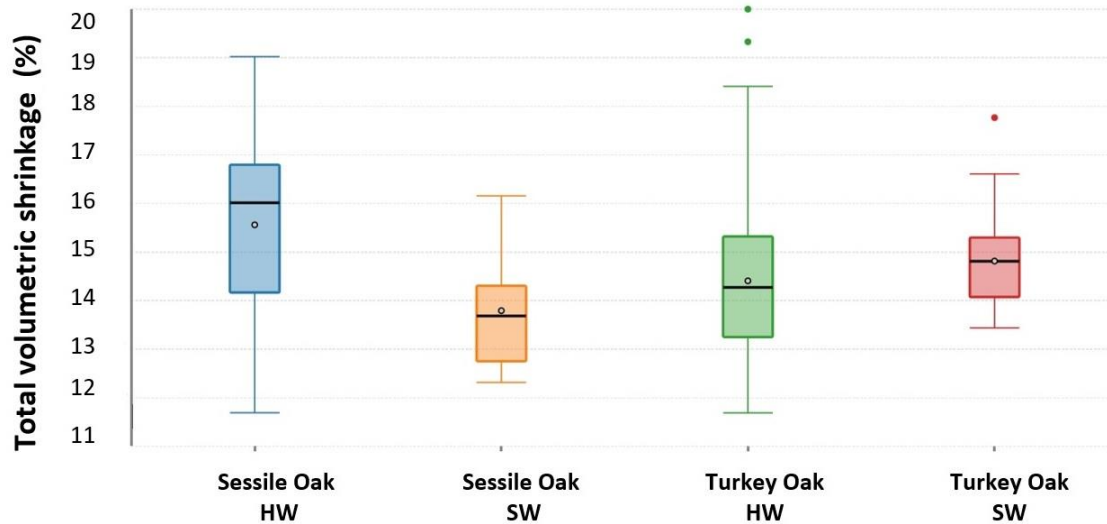

Fig. 13. Volumetric shrinkage of Turkey oak and sessile oak sapwood and heartwood

In close correlation to the density, the values obtained for the volumetric shrinkage of Turkey oak sapwood and heartwood were very similar, with slightly higher value in sapwood, but with no significant difference between them ($p\text{-value} > 0.05$)(see Table 11).

According to the obtained results, Turkey oak sapwood shrinks significantly more than sessile oak sapwood ($p\text{-value} < 0.05$)(see Table 12), which can be explained by the higher density of the first. However, in the case of the heartwood the situation is inverse, as Turkey oak heartwood shrinks significantly less than sessile oak heartwood, although it has higher density. This behavior must be the result of a complex of factors, which includes structural peculiarities and chemical composition.

Table 11. ANOVA Results Regarding the Comparison Between the Volumetric Shrinkage of Turkey Oak Sapwood and Heartwood

Groups	Count	Sum	Average	Variance	SD
Turkey oak HW	79	1138.18	14.41	2.50	1.58
Turkey oak SW	19	281.48	14.81	1.23	1.11

Source of Variation	SS	df	MS	F	P-value	F crit
Between Groups	2.54	1	2.54	1.121	0.292	3.94
Within Groups	217.41	96	2.26			
Total	219.95	97				

Table 12. ANOVA Results Regarding the Comparison the Volumetric Shrinkage of Turkey Oak and Sessile Oak Sapwood

Groups	Count	Sum	Average	Variance	SD
Turkey oak SW	19	281.48	14.81	1.23	1.11
Sessile oak SW	16	220.70	13.79	1.31	1.15

Source of Variation	SS	df	MS	F	P-value	F crit
Between Groups	9.05	1	9.05	7.136	0.012	4.14
Within Groups	41.86	33	1.27			
Total	50.91	34				

Table 13. ANOVA Results Regarding the Comparison Between the Volumetric Shrinkage of Turkey Oak and Sessile Oak Heartwood

Groups	Count	Sum	Average	Variance	SD
Turkey oak HW	79	1138.18	14.41	2.50	1.58
Sessile oak HW	118	1836.19	15.56	2.87	1.70

Source of Variation	SS	df	MS	F	P-value	F crit
Between Groups	62.96	1	62.96	23.10	3.06423E-06	3.89
Within Groups	531.50	195	2.73			
Total	594.46	196				

Fiber Saturation Point

The values of the fiber saturation point of the four wood types, as resulted from Eq. (10), are presented in Fig. 14. The statistical analysis of the results is presented in Tables 14, 15, and 16. Same as in the case of the volumetric shrinkage, it can be noticed that the values for Turkey oak wood (23 to 24%) are lower than those obtained for the sessile oak wood (25 to 28%). In close correlation to the density differences, the average value of the FSP in Turkey oak sapwood was slightly higher (23.8%) than in heartwood (23.3%), but the difference is statistically not significant ($p\text{-value} > 0.05$). The values obtained for sessile oak within this research fit well into the interval obtained by Beldeanu (2001) for the same species.

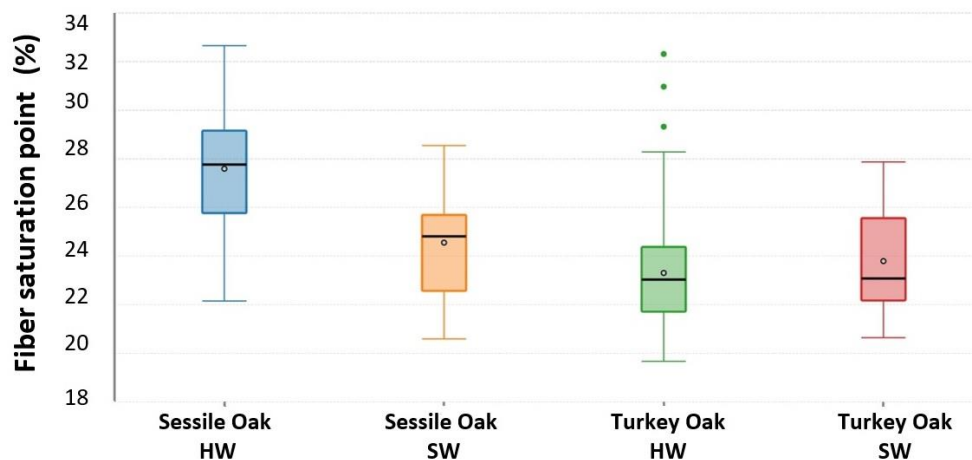
**Fig. 14.** Fiber saturation domain of Turkey oak and sessile oak sapwood and heartwood**Table 14.** ANOVA Results Regarding the Comparison Between the Fiber Saturation Point of Turkey Oak Sapwood and Heartwood

Groups	Count	Sum	Average	Variance	SD
Turkey oak SW	79	1841.182	23.306	5.99	2.44
Turkey oak HW	19	452.0765	23.793	5.17	2.27

Source of Variation	SS	df	MS	F	P-value	F crit
Between Groups	3.69	1	3.638	0.62	0.431	3.94
Within Groups	560.67	96	5.840			
Total	564.31	97				

Table 15. ANOVA Results Regarding the Comparison Between the Fiber Saturation Point of Turkey Oak and Sessile Oak Sapwood

Groups	Count	Sum	Average	Variance	SD	
Turkey oak HW	19	452.0765	23.793	5.174	2.27	
Sessile oak HW	16	392.8499	24.553	4.708	2.17	
Source of Variation	SS	df	MS	F	P-value	F crit
Between Groups	5.011	1	5.011	1.009	0.322	4.139
Within Groups	163.76	33	4.962			
Total	168.77	34				

Table 16. ANOVA Results Regarding the Comparison Between the Fiber Saturation Point of Turkey Oak and Sessile Oak Heartwood

Groups	Count	Sum	Average	Variance	SD	
Turkey oak HW	79	1841.182	23.30	5.99	2.45	
Sessile oak HW	118	3255.725	27.59	5.23	2.29	
Source of Variation	SS	df	MS	F	P-value	F crit
Between Groups	868.76	1	868.76	156.89	8.57E-27	3.89
Within Groups	1079.80	195	5.54			
Total	1948.56	196				

CONCLUSIONS

1. The earlywood pores are bigger in Turkey oak than in sessile oak. In the heartwood, they are partly filled with tyloses, in both wood species.
2. Turkey oak has a much lower proportion of sapwood than sessile wood.
3. In both species, the heartwood has a distinct (darker) color than sapwood. The color difference is higher in sessile oak than in Turkey oak.
4. With both species, the annual ring width is higher in the central area, then it decreases towards the periphery, and it increases again in the sapwood area.
5. The comparative Fourier transform infrared (FTIR) analysis of the main chemical compounds of the two species revealed a similar qualitative chemical composition (with similar absorbance peaks) for all four wood types. However, small differences in the relative intensity of several peaks could be established, which suggest some quantitative differences based on the proportion/ratio between certain compounds.
6. Turkey oak sapwood has a higher amount of extractable substances than the heartwood of this species, close to the maximum values, which were obtained for sessile oak heartwood.
7. The density of Turkey oak wood is significantly higher than that of sessile oak wood. Similar values were obtained both in the sapwood and in the heartwood of this species. This indicates that the drying of wide lumber pieces, containing both sapwood and heartwood is possible without causing major defects (cracks).

8. The oven-dry density variation in radial direction follows the pattern of the annual ring widths, for both species: it is higher in the central region, and at the periphery (in the sapwood area). Over the tree height, the maximum density values were obtained below the crown, and the minimum ones at 1/3 of the tree height, for both species.
9. The linear and volumetric shrinkage coefficients of Turkey oak wood are lower than those recorded for sessile oak.
10. The shrinkage anisotropy has close values for all four wood types, with no significant differences between them.
11. The fiber saturation point is higher for sessile oak than for Turkey oak.

The obtained results are important for the better understanding of the characteristics of Turkey oak wood and its drying behavior, compared to the more common sessile oak wood. Thus, the higher density of Turkey wood (which is similar to acacia and hornbeam wood), as well as the lower fiber saturation point hint towards a longer necessary drying time of this species. Due to the high density, high casehardening risk, and high internal stresses are to be expected in the thick lumber boards. The high amount of extractive substances in sapwood might cause undesired discoloration during drying. All these aspects are to be investigated in further studies.

REFERENCES CITED

- Bajraktari, A. (2018). *Wood Quality of Quercus cerris from Kosovo*, Ph. D. Dissertation, Lisbon University, Lisbon, Portugal.
- Bajraktari, A., Nunes, L., Knapic, S., Pimenta, R., Pinto, T., Duarte, S., Miranda, I., and Pereira, H. (2018). "Chemical characterization, hardness and termite resistance of *Quercus cerris* heartwood from Kosovo," *Maderas Ciencia y Tecnologia* 20(3), article 305314.
- Balzano, A., Cufar, K., Krže, L., and Merela, M. (2020). "Wood identification of charcoal with Confocal Laser Scanning Microscopy," *Les/Wood* 69 (21-35). DOI: 10.26614/les-wood.2020.v69n02a02.
- Beck, H. E., Zimmermann, N. E., McVicar, T. R., Vergopolan, N., Berg, A., and Wood, F. E. (2018). "Present and future Köppen-Geiger climate classification maps at 1-km resolution," *Sci. Data* 5, article 180215.
- Beldeanu, E. (2001). *Forest Products and Wood Anatomy. Vol. I*, Publishing House of Transilvania University, Brasov, Romania. ISBN 973-9474-80-2. (in Romanian).
- De Rigo, D., Enescu, C. M., Durrant, T. H., and Caudullo, G. (2016). "*Quercus cerris* in Europe: Distribution, habitat, usage and threats," in: *European Atlas of Forest Tree Species*, Publication Office of the European Union, Luxembourg.
- Doczekalska, B., and Zborowska, M. (2010). "Wood chemical composition of selected fast growing species treated with NaOH. Part 1: Structural substances," *Wood Research* 55 (1), 2010, pp. 41-48
- Carvalho, A. (1997). *Madeiras Portuguesas*, Vol. II, Lisboa, Direcção-Geral das Florestas.
- Faix, O. (1991). "Classification of lignins from different botanical origins by FT-IR spectroscopy," *Holzforschung* 45(s1), 21-28. DOI: 10.1515.hfsg.1991.45.s1.21.

- Fengel, D., and Wegener, G. (1984). *Wood – Chemistry, Ultra-structure, Reactions*, Walter de Gruyter, Berlin and New York.
- Ferrari, S., Allegrètti, O., Cuccui, I., Moretti, N., Marra, M., and Todaro, L. (2013). “A reevaluation of Turkey oak wood (*Quercus cerris* L.) through combined steaming and thermo-vacuum treatments,” *BioResources* 8(4), 5051-5166, DOI: 10.15376/biores.8.4.5051-5066.
- Filipovici, J. (1965). *Study of Wood, Vol. II*, Didactic Publishing House, Bucharest, Romania. (in Romanian)
- Gierlinger, N., Jacques, D., Schwanninger, M., Wimmer, R., and Pâques, L.E. (2004). “Heartwood extractives and lignin content of different larch species (*Larix* sp.) and relationships to brown-rot decay-resistance,” *Trees* 18(2), 230-236. DOI: 10.1007/s00468-003-0300-0
- Gierlinger, N., Goswami, L., Schmidt, M., Burgert, I., Coutand, C., Rogge, T., and Schwanninger, M. (2008). “*In situ* FT-IR microscopic study on enzymatic treatment of poplar wood cross-sections,” *Biomacromolecules* 9(8), 2194-2201. DOI: 10.1021/bm800300b
- Giordano, G. (1981). *Tecnologia del Legno*. Vol. 3, UTET, Torino.
- Glass, S. V., and Zelinka, S. L. (2010). “Moisture relation and physical properties of wood,” in: *Wood Handbook. Wood as an Engineering Material. Centennial Edition*. General Technical Report FPL–GTR–190. Madison, WI: U.S. Department of Agriculture, Forest Service, Forest Products Laboratory, Chapter 4.
- Gravetter, F. J., and Wallnau, L. B. (2011). *Essentials of Statistics for the Behavioral Sciences*, Seventh Edition, Wadsworth, Cengage Learning, Belmont, CA, USA.
- Holzatlas (2008). Carl-Hanser Verlag GmbH & Co. KG, Munich, Germany. Editor: Wagenführ, R.
https://joint-research-centre.ec.europa.eu/european-atlas-forest-tree-species/sessile-oak_en
- ISO 4469 (1981). “Wood – Determination of radial and tangential shrinkage,” International Organization for Standardization, Geneva, Switzerland.
- ISO 7858 (1982). “Wood – Determination of volumetric shrinkage,” International Organization for Standardization, Geneva, Switzerland.
- ISO 4471 (1982). “Wood – Sampling sample trees and logs for determination of physical and mechanical properties of wood in homogeneous stands,” International Organization for Standardization, Geneva, Switzerland.
- ISO 13061-2 (2014). “Physical and mechanical properties of wood — Test methods for small clear wood specimens — Part 2: Determination of density for physical and mechanical tests,” International Organization for Standardization, Geneva, Switzerland.
- Lavisci, P., Scalbert, A., Masson, D., and Janin, G. (1991). “Quality of Turkey oak (*Quercus cerris* L.) wood. Soluble and insoluble proanthocyanidins,” *Holzforchung* 45(4), 291-296. DOI: 10.1515/hfsg.1991.45.4.291.
- Lee, M., Jeong, S. H., and Mun S. P. (2020). “Conditions for the extraction of polyphenols from radiata pine (*Pinus radiata*) bark for bio-foam preparation,” *J. Korean Wood Sci. Technol.* 48(6), 861-868. pISSN: 1017-0715 eISSN: 2233-7180 DOI: 10.5658/WOOD.2020.48.6.861
- Lehr, M., Miltner, M., and Friedl, A. (2021). “Removal of wood extractives as pulp (pre-)treatment: A technological review,” *SN Applied Sciences* 3, 886. DOI: 10.1007/s42452-021-04873-1

- Lo Monaco, A., Todaro, L., Sarlatto, M., Spina, R., Calienno, L., and Picchio, R. (2011). "Effect of moisture on physical parameters of timber from Turkey oak (*Quercus cerris* L.) coppice in Central Italy," *For. Stud. China* 13(4), 276-284. DOI: 10.1007/s11632-013-0405-5.
- Manetti, M. C. (2002). "Tree ring growth by core sampling at the CONECOFOR permanent monitoring plots. The deciduous oak (*Quercus cerris* L.) type," *Journal of Limnology* 61(1), 55-61.
- Merela, M., and Cufar, K. (2013). "Mechanical properties of sapwood versus heartwood, in three different oak species," *Drvna Industrija* 64(4), 323-334. DOI: 10.5552/drind.2013.1325.
- Nunes, L. (2017). *Caracterização da Madeira de Quercus cerris - Análise Anatômica, Análise Dendrocronológica e Ensaaios de Dureza*, Master's Thesis, University of Lisbon, Lisbon, Portugal.
- Oleksik, M., and Roșca, L. (2023). *Data analysis with Microsoft Excel*, Pro Universitaria Publishing House, Bucharest, Romania. (in Romanian)
- Pallant, J. (2007). *SPSS. Survival Manual. A Step-by-step Guide to Data Analysis Using SPSS Version 15*, Third Edition, McGraw Hill, Open University Press
- Pandey, K. K., and Pitman, A. (2003). "FTIR studies of the changes in wood chemistry following decay by brown-rot and white-rot fungi," *International Biodeterioration & Biodegradation* 52, 151-160. DOI:10.1016/S0964-8305(03)00052-0
- Pasztory, Z., Börcsök, Z., Ronzecz, I., Mohacsi, K., and Molnar, S. (2014). "Oven-dry density of sessile oak, Turkey oak and hornbeam in different regions of Mecsek mountain," *Wood Research* 59(2), 683-694.
- Popescu, C.-M., Vasile, C., Popescu, M.-C., Singurel, G., Popa, V., and Munteanu, B. (2006). "Analytical methods for lignin characterization. II. Spectroscopic studies," *Cellulose Chemistry and Technology* 40, 597-621.
- Popescu, C.-M., Popescu, M.-C., Singurel, G., Vasile, C., Argyropoulos, D. S., and Willfor, S. (2007). "Spectral characterization of eucalyptus wood," *Applied Spectroscopy* 61(11), 1168-1177. DOI:10.1366/000370207782597076
- Popescu, C.-M., Singurel, G., Popescu, M.-C., Vasile, C., Argyropoulos, D. S., and Willför, S. (2009). "Vibrational spectroscopy and X-ray diffraction methods to establish the differences between hardwood and softwood," *Carbohydrate Polymers* 77(4), 851-857. DOI: 10.1016/j.carbpol.2009.03.011
- Prosiński, S. (1984). *Chemia Drewna* (Wood chemistry, in Polish language). PWRiL, W-wa, Pp. 86-91
- Richter, H. G., and Dallwitz, M. J. (2000). "Commercial timbers: Descriptions, illustrations, identification, and information retrieval," DELTA database (<https://www.delta-intkey.com/wood/en/index.htm>), Accessed 15.10.2022.
- Rocha, M., Veiga, T., Soares, B., de Araujo, A., Carvalho, A., Hein, P. (2019). "Do the growing conditions of trees influence the wood properties?," *Floresta e Ambiente*. DOI: 10.1590/2179-8087.035318.
- Stafasani, M., and Toromani, E. (2015). "Growth climate response of young Turkey oak (*Quercus cerris* L.) coppice forest stands along longitudinal gradient in Albania," *South-east European Forestry* 6(1), 25-38. DOI: 10.15177/seefor.15-05
- Stafasani, M., Devolli, A., Feta, D., and Shahinasi, E. (2018). "The solubility of Turkey oak (*Quercus cerris* L.) wood in water," *Albanian Journal of Agricultural Sciences* 634-640.

- Tamburini, D., Lucejko, J., Pizzo, B., Mohammed, M., Sloggett, R., and Colombini, M., (2017). "A critical evaluation of the degradation state of dry archaeological wood from Egypt by SEM, ATR-FTIR, wet chemical analysis and Py(HMDS)-GC-MS," *Polymer Degradation and Stability* 146, 140-154. DOI: 10.1016/j.polymdegradstab.201
- Tolvaj, L., Molnar, Z., and Nemeth, R. (2013). "Photodegradation of wood at elevated temperature: Infrared spectroscopic study," *J. Photochem. Photobiol. B* 121, 32-36.
- Traoré, M., Kaal, J., and Martínez Cortizas, A. (2018). "FTIR and Py-GC-MS data of wood from various living oak species and Iberian shipwrecks," *Data Brief*. 10;21, 1861-1863. DOI: 10.1016/j.dib.2018.11.032. PMID: 30519608; PMCID: PMC6260304
- Uzielli, L. (1989). "Valorizzazione tecnologica del legno di cerro," (Technological valorization of Turkey oak wood)," *L'Italia Forestale e Montana*, 46(3), 222-237. (in Italian).
- Vavrcik, H., and Gryc, V. (2012). "Analysis of the annual ring structure and wood density relations in English oak and sessile oak," *Wood Research* 57(4), 573-580.
- Woodcock, D., and Shier, A. (2002). "Wood specific gravity and its radial variations: The many ways to make a tree," *Trees* 16, 437-443. DOI: 10.1007/s00468-002-0173-7. Wood Database (<https://www.wood-database.com/english-oak/> and <https://www.wooddatabase.com/turkey-oak/>), Accessed 15.10.2022.
- Zeidler, A., and Boruvka, V. (2016). "Wood density of Northern red oak and pedunculate oak grown in former brown coal mine in the Czech Republic," *BioResources* 11(4), 9373-9385. DOI: 10.15376/biores.11.4.9373-9385.

Article submitted: February 23, 2023; Peer review completed: March 18, 2023; Revised version received and accepted: July 5, 2023; Published: July 10, 2023.
DOI: 10.15376/biores.18.3.5724-5749